

2022 —

# PRODUCT CATALOG



# A “FULL SERVICE” since 1965! —

Lourens van der Spruijt, our father and founder of Elvedes registered his own business with the Chamber of Commerce on February 8, 1965. He started with parts for mopeds, such as cables, sprockets, chains, pistons, buddy seats etc. Stock was kept under his bed and in his Opel Rekord. His first sale was one day later at a bike shop Staals in Utrecht.

For several years he visited bike shops directly to make sales. The demand for cables was remarkably high and it seemed this was something to put his focus on. Soon, Lourens started to assemble brake, throttle, clutch and speedometer cables for mopeds himself in his mother's kitchen. Elvedes changed from a moped parts trading company into a control cable business for mopeds and bicycles. Because there was no time left to

visit bike shops, he decided to work together with wholesale partners, who took care of the distribution for the Elvedes aftermarket cables. Besides aftermarket there was a large OEM market for brake and shift cables for bicycles.

In 2002 it was time for us, the next generation, to run the Elvedes business. We, his twin sons Carl and Peter, who were 24 years old at the time, started to find out where Elvedes was standing after 37 years, and where it had to go for the years to follow. We decided to put more focus on aftermarket and less on OEM products. Making the Elvedes brand bigger and stronger gives the company more certainty and continuity for the future. Besides cables, there were so many more service parts for bicycles which would be a perfect addition to expand the brand.



# INDEX

First, we started to add rim and disc brake pads. Not only the most wanted, but also the exotic brake pads. If you want to be a “full service” aftermarket brand, you must add the full range and help your customer to find the right Elvedes product by providing “easy to find” product posters and “how to use” online videos. The market was enthusiastic, and from that point we started to extend the Elvedes WWproduct range step by step. Nowadays, there is a large assortment of Elvedes service parts for bicycles, which find their way all over Europe and further afield. All this success is achieved with a great team of Elvedes employees, our hard-core production partners and our professional distribution partners.

For the upcoming years, Elvedes will update and innovate their current product range, but will also expand with new product groups to highlight the “full service” brand that we are.

**We believe that “full service” are the keywords to success. “Full service” to our Elvedes team, since our team is the most valuable part of our company. “Full service” to our production partners, because only together can we create the best products for the best price, and “full service” to our distribution partners, whose needs we are always trying to fill and make the Elvedes brand a significant asset for their businesses.**

<b>04</b>	<b>BRAKE</b>
05	DISC BRAKE SYSTEMS
07	CALIPER ADAPTERS
08	DISC BRAKE ROTORS
11	DISC BRAKE PARTS
12	DISC BRAKE PADS
20	RIM BRAKE PADS

<b>24</b>	<b>CABLE</b>
25	INNER CABLES
28	OUTER CABLES
29	ATB/RACE CABLES
30	CABLE KITS
34	CABLE PARTS

<b>40</b>	<b>HYDRO</b>
41	ORIGINAL BRANDS
44	HYDRO COMPONENTS
46	SHIMANO HYDRO COMPONENTS
47	O-RINGS

<b>48</b>	<b>ROTATION</b>
49	BEARINGS
52	HEADSET BEARINGS
55	HEADSET PARTS
56	PULLEY WHEELS
58	BOTTOM BRACKET GUIDE
62	BOTTOM BRACKETS
64	BOTTOM BRACKET PARTS

<b>66</b>	<b>TOOLS AND MAINTENANCE</b>
67	MAINTENANCE
68	CABLE TOOLS
69	MORE TOOLS
70	HYDRO TOOLS
71	BOTTOM BRACKET TOOLS

<b>72</b>	<b>WORKSHOP</b>
73	TRANSIT
74	BOXER
75	PARTNER
76	CADDY
77	PADFINDER
78	DISCOVERY

# BRAKE



## MP1000 MECHANICAL DISC BRAKE CALIPER

2017130

Post mount  
1 pce

Dual piston disc brake caliper



## MP1000 MECHANICAL DISC BRAKE CALIPER

2019097

Flat mount  
1 pce

Dual piston disc brake caliper



## MP1000 MECHANICAL DISC BRAKE CALIPER

2019098

Post mount TWIN  
1 pair left + right

Dual piston disc brake caliper



Left

Right

## MECHANICAL DISC BRAKE LEVER

2,5 - 3 finger

2017131	Left + right hand	1 pair
2018054	Left hand	1 pce
2018055	Right hand	1 pce



### BRAKE

DISC BRAKE SYSTEMS

CALIPER ADAPTERS

DISC BRAKE ROTORS

DISC BRAKE PARTS

DISC BRAKE PADS

RIM BRAKE PADS

### CABLE

INNER CABLES

OUTER CABLES

ATB/RACE CABLES

CABLE KITS

CABLE PARTS

### HYDRO

ORIGINAL BRANDS

HYDRO  
COMPONENTS

SHIMANO HYDRO  
COMPONENTS

O-RINGS

### ROTATION

BEARINGS

HEADSET BEARINGS

HEADSET PARTS

PULLEY WHEELS

BOTTOM BRACKET  
GUIDE

BOTTOM BRACKETS

BOTTOM BRACKET  
PARTS

### TOOLS AND MAINTENANCE

MAINTENANCE

CABLE TOOLS

MORE TOOLS

HYDRO TOOLS

BOTTOM BRACKET  
TOOLS

### WORKSHOP

TRANSIT

BOXER

PARTNER

CADDY

PADFINDER

DISCOVERY

# DISC BRAKE SYSTEMS

## HP4000 HYDRAULIC DISC BRAKE SET

2017132

Mineral oil system  
2.5 - 3 finger lever  
Dual piston disc brake caliper

Replacement disc brake pads for HP4000: 6890 model

Replacement Ø160mm rotor: 2018053

Spare hose fitting set for HP4000: CP2020139

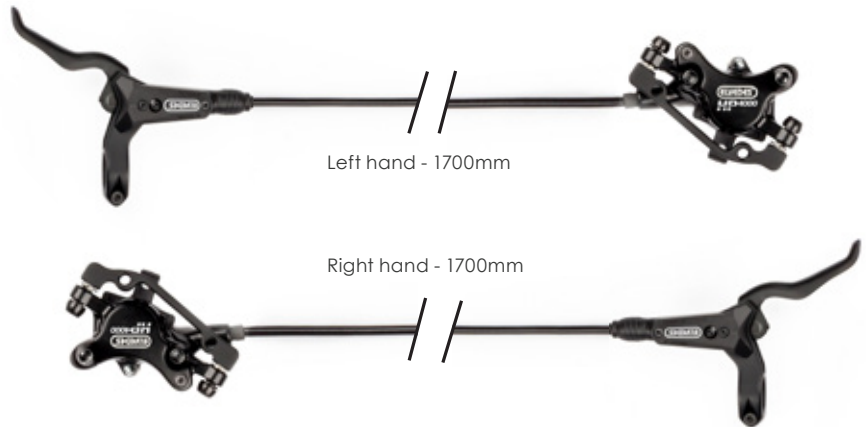

## HP4000 HYDRAULIC DISC BRAKE SET LEFT HAND

2018108



## HP4000 HYDRAULIC DISC BRAKE SET RIGHT HAND

2018107



## CALIPER ADAPTER

Adapter types are indicated caliper to frame  
(e.g. PM-IS = PM caliper to IS frame/fork)  
Bolts are included with every adapter



### CP2017071

PM - IS

Ø160 front  
Ø140 rear



### CP2017072

PM - IS

Ø180 front  
Ø160 rear



### CP2015167

PM - IS

Ø180 rear



### CP2015162

PM - IS

Ø203 front



### CP2015168

PM - IS

Ø203 rear



### CP2015158

PM - PM before 2013

Ø180



### CP2016117

PM - PM after 2013

Ø140 → Ø160  
Ø160 → Ø180



### CP2015159

PM - PM

Ø160 → Ø203



### CP2018058

PM - PM

Ø180 → Ø203



### CP2019046

FM - PM

Ø140 front



### CP2019047

FM - PM

Ø140 rear



### CP2019048

FM - PM

Ø160 front



### CP2019045

FM - PM

Ø160 rear



### CP2019044

FM - FM

Ø140 front  
Ø160 front



### CP2017160

FM - FM

Ø160 rear



## BRAKE

DISC BRAKE SYSTEMS

CALIPER ADAPTERS

DISC BRAKE ROTORS

DISC BRAKE PARTS

DISC BRAKE PADS

RIM BRAKE PADS

## CABLE

INNER CABLES

OUTER CABLES

ATB/RACE CABLES

CABLE KITS

CABLE PARTS

## HYDRO

ORIGINAL BRANDS

HYDRO COMPONENTS

SHIMANO HYDRO COMPONENTS

O-RINGS

## ROTATION

BEARINGS

HEADSET BEARINGS

HEADSET PARTS

PULLEY WHEELS

BOTTOM BRACKET GUIDE

BOTTOM BRACKETS

BOTTOM BRACKET PARTS

## TOOLS AND MAINTENANCE

MAINTENANCE

CABLE TOOLS

MORE TOOLS

HYDRO TOOLS

BOTTOM BRACKET TOOLS

## WORKSHOP

TRANSIT

BOXER

PARTNER

CADDY

PADFINDER

DISCOVERY

# DISC BRAKE ROTORS

## SC ROTOR

Stainless steel with aluminium Centra-lock

2020071	SC14	Ø140 mm	130 g
2020072	SC16	Ø160 mm	154 g
2020073	SC18	Ø180 mm	180 g
2020116	SC20	Ø203 mm	230 g

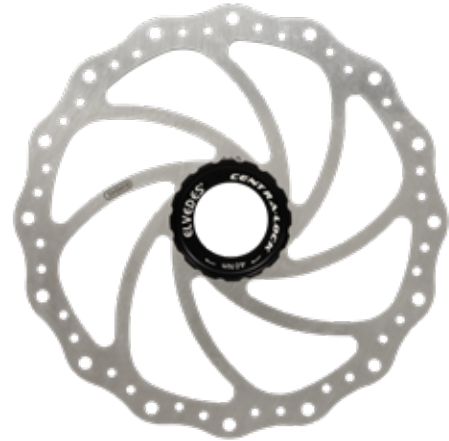

## SX ROTOR

Stainless steel, 6 holes, including rotor bolts

2014069	SX14	Ø140 mm	86 g
6820	SX16	Ø160 mm	138 g
6821	SX18	Ø180 mm	151 g
2017092	SX20	Ø203 mm	188 g



## HP ROTOR

Stainless steel, 6 holes, including rotor bolts

2018053	HP16	Ø160 mm	96 g
2019057	HP18	Ø180 mm	127 g





## LX16 LIGHT WEIGHT ROTOR

Stainless steel, 6 holes, including rotor bolts

2015194	Black	Ø160 mm	85 g
2015195	Blue	Ø160 mm	85 g
2015196	Red	Ø160 mm	85 g
2021066	Stainless	Ø160 mm	85 g



## LX18 LIGHT WEIGHT ROTOR

Stainless steel, 6 holes, including rotor bolts

2015197	Black	Ø180 mm	112 g
2015198	Blue	Ø180 mm	112 g
2015199	Red	Ø180 mm	112 g
2021067	Stainless	Ø180 mm	112 g



## BMX ROTOR

Stainless steel, 6 holes, including rotor bolts

2019055	Ø120 mm
---------	---------

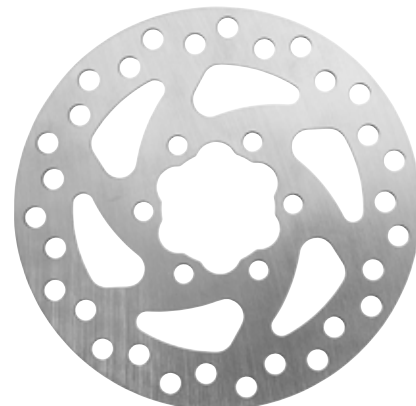

### BRAKE

- DISC BRAKE SYSTEMS
- CALIPER ADAPTERS
- DISC BRAKE ROTORS
- DISC BRAKE PARTS
- DISC BRAKE PADS
- RIM BRAKE PADS

### CABLE

- INNER CABLES
- OUTER CABLES
- ATB/RACE CABLES
- CABLE KITS
- CABLE PARTS

### HYDRO

- ORIGINAL BRANDS
- HYDRO COMPONENTS
- SHIMANO HYDRO COMPONENTS
- O-RINGS

### ROTATION

- BEARINGS
- HEADSET BEARINGS
- HEADSET PARTS
- PULLEY WHEELS
- BOTTOM BRACKET GUIDE
- BOTTOM BRACKETS
- BOTTOM BRACKET PARTS

### TOOLS AND MAINTENANCE

- MAINTENANCE
- CABLE TOOLS
- MORE TOOLS
- HYDRO TOOLS
- BOTTOM BRACKET TOOLS

### WORKSHOP

- TRANSIT
- BOXER
- PARTNER
- CADDY
- PADFINDER
- DISCOVERY

# DISC BRAKE ROTORS

## FX16 FLOATING ROTOR

Stainless steel and aluminium, 6 holes, including rotor bolts

2015146	Black	Ø160 mm	108 g
2015147	Blue	Ø160 mm	108 g
2015148	Red	Ø160 mm	108 g



## FX18 FLOATING ROTOR

Stainless steel and aluminium, 6 holes, including rotor bolts

2015149	Black	Ø180 mm	132 g
2015150	Blue	Ø180 mm	132 g
2015151	Red	Ø180 mm	132 g



## CRX COOLING ROTOR

Stainless steel and aluminium, 6 holes, including rotor bolts

2017162	CRX14	Ø140 mm	101 g
2017163	CRX16	Ø160 mm	127 g
2017164	CRX18	Ø180 mm	152 g



## ROTOR ACCESSORIES

### CP2012048

CNC Centra-lock  
Adapter with lock ring  
Aluminium  
1 pce



### 2021068

CNC Centra-lock  
Lock ring  
Aluminium  
1 pce



### 2019068

Rotor shim  
0,1 mm  
Stainless steel  
8 pcs



### 2019054

Rotor shim  
0,2 mm  
Stainless steel  
8 pcs



### 2017149

Rotor shim  
1,0 mm  
Stainless steel  
1 pce



### CP2015153

Rotor bolt  
Torx head  
Titanium CNC  
6 pcs



### 2017187

Rotor bolt  
Torx head  
Stainless steel  
12 pcs



### ELV2015157

Rotor bolt  
Torx head  
Stainless steel  
100 pcs



## PINS AND CLIPS

### 2017178

Set screw  
Magura Marta,  
Gustava, Louise  
2007  
M4×22,5  
10 pcs



### 2017179

Fixing pin  
Shimano Deore,  
Avid Elixir 1/3  
35mm  
30 pcs



### 2017180

Fixing pin  
Hayes, Hope  
45mm  
10 pcs



### 2017181

Fixing bolt  
Avid Elixir 5/7/9,  
Guide, Code, Trail  
M4×22  
20 pcs



### 2017182

Fixing bolt  
Shimano XT, XTR,  
Magura MT 2/4/6/8,  
Tektro, Formula Oro  
M4×27  
20 pcs



### 2017183

Fixing bolt  
Hayes Ryde,  
Dyno  
M4×36  
10 pcs



### 2017184

Fixing bolt  
Formula Mega,  
Hope E4/V4/  
X2/V2  
M5×25  
10 pcs



### 2020247

Clip  
M4/M5  
10 pcs



### 2020248

Clip  
SRAM  
10 pcs



## BRAKE

DISC BRAKE SYSTEMS  
CALIPER ADAPTERS  
DISC BRAKE ROTORS  
DISC BRAKE PARTS  
DISC BRAKE PADS  
RIM BRAKE PADS

## CABLE

INNER CABLES  
OUTER CABLES  
ATB/RACE CABLES  
CABLE KITS  
CABLE PARTS

## HYDRO

ORIGINAL BRANDS  
HYDRO  
COMPONENTS  
SHIMANO HYDRO  
COMPONENTS  
O-RINGS

## ROTATION

BEARINGS  
HEADSET BEARINGS  
HEADSET PARTS  
PULLEY WHEELS  
BOTTOM BRACKET  
GUIDE  
BOTTOM BRACKETS  
BOTTOM BRACKET  
PARTS

## TOOLS AND MAINTENANCE

MAINTENANCE  
CABLE TOOLS  
MORE TOOLS  
HYDRO TOOLS  
BOTTOM BRACKET  
TOOLS

## WORKSHOP

TRANSIT  
BOXER  
PARTNER  
CADDY  
PADFINDER  
DISCOVERY

# DISC BRAKE PAD GUIDE

## HOW TO EXTEND THE LIFETIME OF YOUR DISC BRAKE PADS

Bed-in disc brake pads extend the life span of the pads considerably! Squeeze them in carefully and ensure that the pad just audibly touches the brake disc for approximately 100 metres at a speed of  $\pm 25$  km/hour. Now squeeze a little harder on the brake so that the speed decreases to approximately 5 km/hour, and then slowly increase the speed while gently squeezing the brake. Repeat this 10-12 times and the pads are worn in. Never brake to a stop with the brake still squeezed in order to prevent damage to the rotor. Always bed-in the front and rear brakes separately.

## WHY ELVEDES DISC BRAKE PADS?

Elvedes believes that offering 3 different compounds can satisfy all riders in different circumstances with different bikes. Our compounds are compatible with all brands and types of stainless steel rotors on the market and will give you the brake power you will need. In the overview below, the performance of each compound is simply explained to easily make the right choice of disc brake pads.

### ORGANIC (RESIN) COMPOUND

Excellent for gravel bikes, racing bikes and trekking bikes



### METALLIC CARBON (SEMI-METAL) COMPOUND

Excellent for E-bikes, cargo bikes and delivery bikes



### SINTERED (METAL) COMPOUND

Excellent for mountain bikes



## ORDER QUANTITY

All organic, sintered and metallic carbon disc brake pads have a steel backplate.

### XXXX -CARD

All disc brake pads can be ordered per card, containing 1 pair.

Necessary pins and clips included with all types of disc brake pads on card.



### XXXX -BOX

Selected disc brake pads can be ordered per box, containing 10 pairs.



### XXXX -BOX25

Selected disc brake pads can be ordered per box, containing 25 pairs.

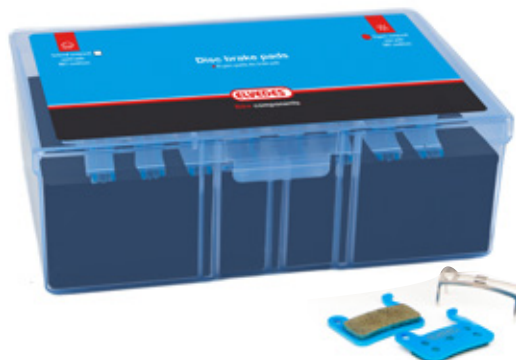

## BRAKE

- DISC BRAKE SYSTEMS
- CALIPER ADAPTERS
- DISC BRAKE ROTORS
- DISC BRAKE PARTS
- DISC BRAKE PADS
- RIM BRAKE PADS

## CABLE

- INNER CABLES
- OUTER CABLES
- ATB/RACE CABLES
- CABLE KITS
- CABLE PARTS

## HYDRO

- ORIGINAL BRANDS
- HYDRO COMPONENTS
- SHIMANO HYDRO COMPONENTS
- O-RINGS

## ROTATION

- BEARINGS
- HEADSET BEARINGS
- HEADSET PARTS
- PULLEY WHEELS
- BOTTOM BRACKET GUIDE
- BOTTOM BRACKETS
- BOTTOM BRACKET PARTS

## TOOLS AND MAINTENANCE

- MAINTENANCE
- CABLE TOOLS
- MORE TOOLS
- HYDRO TOOLS
- BOTTOM BRACKET TOOLS

## WORKSHOP

- TRANSIT
- BOXER
- PARTNER
- CADDY
- PADFINDER
- DISCOVERY

**BRAND** \_\_\_\_\_

- 1 Alhonga
- 2 Assess
- 3 Avid
- 4 Campagnolo
- 5 Cannondale

- 6 Clarks
- 7 Diatech
- 8 Elvedes
- 9 Formula
- 10 Giant

- 11 Grimeca
- 12 Hayes
- 13 Hope
- 14 Logan
- 15 Magura

- 16 Promax
- 17 Quad
- 18 RST
- 19 Shimano
- 20 SRAM

- 21 Suntour
- 22 Tektro
- 23 TRP
- 24 VanMoof
- 25 Zoom

NR	MODEL	ORGANIC	SINTERED	METALLIC CARBON
1	SNG mechanical	6872		6872MC
2	C420, C425, C470	6886		6886MC
	C430	6881		
3	BB3, BB5	6886		6886MC
	BB7, Juicy	6855	6855S	6855MC
	Code, Code 5	6882		
	Code > 2011	6895	6895S	6895MC
	DB1, DB3	6906	6906S	6906MC
4	Elixir	6890	6890S	6890MC
	X0, X7, X9 Trail	6898	6898S	6898MC
5	Coda	6908		
	Clout 1, S2	6865		
6	M1, M2, M3, CMD-22(FM), CMD-23, CMD-27	6854	6854S	6854MC
	M4	6894	6894S	6894MC
	Exo, Skeletal	6891	6891S	6891MC
	CMD-24, HDB-540, HDB-600, HDB-790	6860		
7	CMD-9, CMD-17(R)	6859	6859S	
	CMD-15	6886		6886MC
	Anchor	6855	6855S	6855MC
8	Twincam	6880		
	HP4000	6864		
9	MP1000	6890	6890S	6890MC
	4-Racing, B4 Team	6894	6894S	6894MC
10	C1, Cura, Cura-E, Mega, R1 (R), RO(R), RX, The One	6869		
	Cura 4	6893	6893S	6893MC
	Extreme hydraulic	6909	6909S	6909MC
11	Oro	6869		
	MPH 2000	6867		
12	MPH 2001 - 2003, MPH-2, MPH-3	6863	6863S	
	Root	6852		
13	System 8, 12, 16	6861	6854S	6854MC
	System 13	6853		
14	Dominion A4	6869		
	Dyno, Stroker Ryde	6910	6910S	6910MC
15	El Camino	6888	6888S	
	HFX, MX 1	6885		
16	Prime	6850	6850S	
	Stroker Ace	6896	6896S	
17	Stroker Carbon, Gram, Trail, GX2	6892		
	MX2, MX3, MX4, Sole	6889	6889S	
18	C2, O2	6862		6862MC
	DH4, M4 2002	6852		
19	E4, RX4-SH	6871		
	Mini	6903		
20	Mono 6 2007, 6-Ti 2004, Moto M6	6870		
	Mono M4	6876		
21	Mono Mini	6853		
	Mono Trial, Trial Zone	6877		
22	V2	6887		
	V4	6883		
23	X2	6899	6899S	
	XC4	6911	6911S	6911MC
24	Clara 2000 - 2001, Louise 1999 - 2001	6873		
	Clara 2001 - 2002, Louise (FR) 2002 - 2006	6874		
25	Gustav M 2000 - 2011	6851		
	Julie 2001 - 2008	6857		
26	Julie HP, Louise > 2007, Louise Bat, Louise Carbon, Marta > 2009	6878	6884S	
	Marta 2002 - 2008, Marat SL 2003 - 2008	6856		
27	MT2, MT4, MT6, MT8, MT Sport	6884		
	MT5, MT7	6860		
28	DC320, 610, 610J, 700, DSK400, 601J, Xnine	6897	6897S	6897MC
	DC600	6902	6902S	6902MC
29	DC710, 720, 913, Decipher, DSK-300(R), 310, 330R, 715, Render (R)	6904		
	DC901, 951	6879		
30	DC905, 907, 908, DSK-950	6850	6850S	
	DC910	6886		6886MC
31	Decode R DSK-718R, DSK-909, E-Capsule, F1, Lucid, Solve	6880		
	DSK-810	6855	6855S	6855MC
32	Lucid P4	6851		
	QHD-1	6854	6854S	6854MC
33	D-Power	6854	6854S	6854MC
	mechanical	6866		

NR	MODEL	ORGANIC	SINTERED	METALLIC CARBON
1	105 BR-R7070, BR-RS505	6907	6907S	6907MC
	Acera BR-M3060	6854	6854S	6854MC
2	Alfine BR-S500, 501	6859	6859S	
	Alfine BR-S700	6894	6894S	6894MC
3	Alivio BR-M395, 4050	6854	6854S	6854MC
	Altus BR-M315, 365, 375	6854	6854S	6854MC
4	BR-CX75, BR-R315, 517	6894	6894S	6894MC
	BR-M355, 415, 416, 416A, 445, 447, 465, 475, 485, 486, 495, 575	6854	6854S	6854MC
5	BR-M545, BR-R505, BR-T605	6859	6859S	
	BR-MT520	6891	6891S	6891MC
6	BR-RS305	6907	6907S	6907MC
	Deore BR-M515, 515LA, 525, BR-T 615	6854	6854S	6854MC
7	Deore BR-M535, 595, 596	6859	6859S	
	Deore BR-M555, 555-M	6858		
8	Deore BR-M615, BR-R785, BR-RS785	6894	6894S	6894MC
	Deore LX BR-M585, BR-T665	6859	6859S	
9	Deore LX BR-TX805	6854	6854S	6854MC
	Deore XT BR-M755, 755-DH	6853		
10	Deore XT BR-M765, 775, 776	6859	6859S	
	Deore XT BR-M785, 8000	6894	6894S	6894MC
11	Deore XT BR-M8020	6891	6891S	6891MC
	Dura-ace BR-R9170	6907	6907S	6907MC
12	Hone BR-M601	6859	6859S	
	Metrea BR-U5000	6907	6907S	6907MC
13	Nexave BR-C501, 601	6854	6854S	6854MC
	Nexave BR-C901	6858		
14	Saint BR-M800	6859	6859S	
	Saint BR-M810, 820	6891	6891S	6891MC
15	SLX BR-M665	6859	6859S	
	SLX BR-M666, 675, 7000	6894	6894S	6894MC
16	Sora BR-R317	6894	6894S	w6894MC
	Tiagra BR-RS405	6907	6907S	6907MC
17	Tourney BR-C901	6854	6854S	6854MC
	Ultegra BR-CX77	6894	6894S	6894MC
18	Ultegra BR-R8070, BR-RS805	6907	6907S	6907MC
	XTR BR-M9000, 9020, 985, 987	6894	6894S	6894MC
19	XTR BR-M9120	6891	6891S	6891MC
	XTR BR-M965, 966, 975	6859	6859S	
20	ZEE BR-M640	6891	6891S	6891MC
	700 B1 HRD, Apex, CX1, eTap, Force, HRR, Level TLM, Level Ultimate, Red, Rival, S900	6900	6900S	6900MC
21	9,0	6853		
	Code, Guide RE	6895	6895S	6895MC
22	DB5, Level, Level T, Level TL	6906	6906S	6906MC
	Guide R, Guide RS, Guide RSC, Guide Ultimate	6898	6898S	6898MC
23	Via GT, X0, XX, XX World Cup	6890	6890S	6890MC
	DB XCC-MC	6875		
24	SR1	6879		
	Aquila MD-M500	6854	6854S	6854MC
25	Aries MD-M300	6854	6854S	6854MC
	Auriga E HD-E500, 520, 525, 530	6854	6854S	6854MC
26	Auriga HD-E515, HD-T515, Auriga E HD-E510	6875		
	Auriga HD-M290, 291 HD-T520, 525, 530, Auriga Pro HD-M700	6854	6854S	6854MC
27	Dorado 4P HD-E720, 725, HD-M745	6891	6891S	6891MC
	Dorado HD-E710	6905		
28	Dorado HD-E715	6854	6854S	6854MC
	Draco HD-M350, 351, 352	6854	6854S	6854MC
29	Gemini HD-M500, 501, 510, 520, 521	6854	6854S	6854MC
	HDC HD-M300, 301, 330	6854	6854S	6854MC
30	HD-E350, HD-T285, MD-C510, MD-M280, MD-U510	6854	6854S	6854MC
	HD-R310, 510	6907	6907S	6907MC
31	IO	6868		
	Junior HD-M282	6854	6854S	6854MC
32	Lyra	6901		
	Mira MD-C400	6854	6854S	6854MC
33	Orion 4+2P (front) HD-M735, Orion 4P HD-M745	6891	6891S	6891MC
	Orion HD-M720, 730, Orion 4+2P (rear) HD-M735, Orion SL HD-M740	6854	6854S	6854MC
34	Vela HD-T290	6854	6854S	6854MC
	Volans HD-T700	6875		
35	Volans HD-T710	6854	6854S	6854MC
	Dash Sport, HY/RD, Hylex, Hylex RS	6854	6854S	6854MC
36	HD-C801, Parabox R, Slate X2, Spyke, Spyre	6854	6854S	6854MC
	G-Spec, Quadiem, Slate T4, Zurich	6891	6891S	6891MC
37	Hylex HD-C810, Hylex RS HD-C811, HD-T910	6907	6907S	6907MC
	Model S	6862		6862MC
38	Model X	6862		6862MC
		6872		6872MC

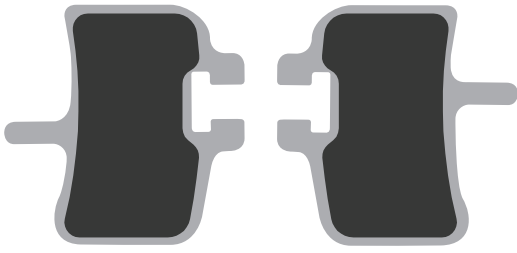

6850 - CARD  
6850 S - CARD

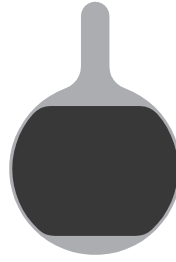

6851 - CARD

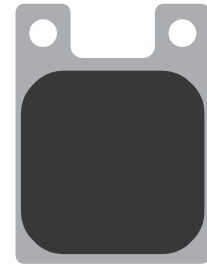

6852 - CARD

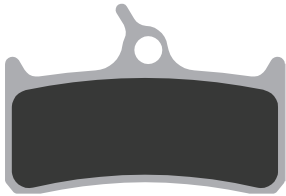

6853 - CARD

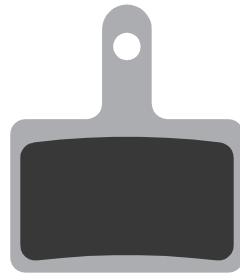

6854 - CARD / -BOX / -BOX25  
6854 S - CARD / -BOX / -BOX25  
6854 MC - CARD / -BOX / -BOX25

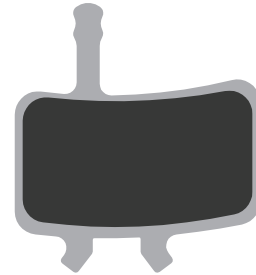

6855 - CARD  
6855 S - CARD  
6855 MC - CARD

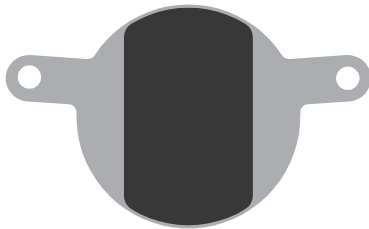

6856 - CARD



6857 - CARD

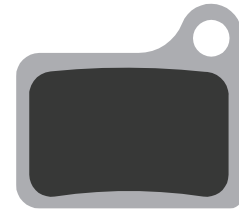

6858 - CARD



6859 - CARD  
6859 S - CARD



6860 - CARD

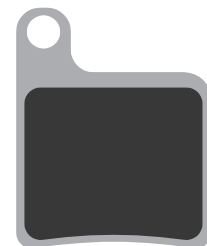

6861 - CARD

## BRAKE

- DISC BRAKE SYSTEMS
- CALIPER ADAPTERS
- DISC BRAKE ROTORS
- DISC BRAKE PARTS
- DISC BRAKE PADS
- RIM BRAKE PADS

## CABLE

- INNER CABLES
- OUTER CABLES
- ATB/RACE CABLES
- CABLE KITS
- CABLE PARTS

## HYDRO

- ORIGINAL BRANDS
- HYDRO COMPONENTS
- SHIMANO HYDRO COMPONENTS
- O-RINGS

## ROTATION

- BEARINGS
- HEADSET BEARINGS
- HEADSET PARTS
- PULLEY WHEELS
- BOTTOM BRACKET GUIDE
- BOTTOM BRACKETS
- BOTTOM BRACKET PARTS

## TOOLS AND MAINTENANCE

- MAINTENANCE
- CABLE TOOLS
- MORE TOOLS
- HYDRO TOOLS
- BOTTOM BRACKET TOOLS

## WORKSHOP

- TRANSIT
- BOXER
- PARTNER
- CADDY
- PADFINDER
- DISCOVERY

# DISC BRAKE PADS



6862 - CARD  
6862 MC - CARD

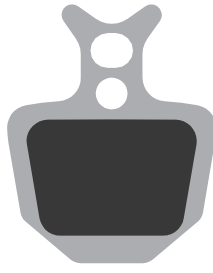

6863 - CARD  
6863 S - CARD



6864 - CARD



6865 - CARD

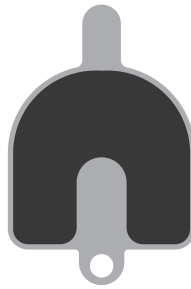

6866 - CARD



6867 - CARD

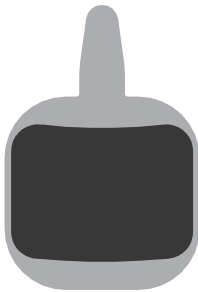

6868 - CARD



6869 - CARD

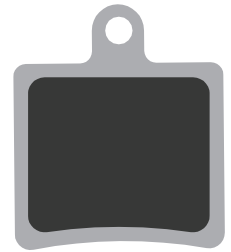

6870 - CARD

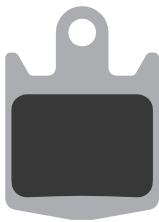

6871 - CARD



6872 - CARD  
6872 MC - CARD

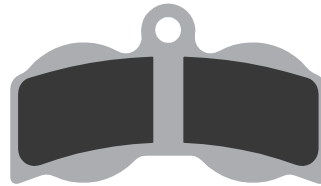

6873 - CARD



6874 - CARD



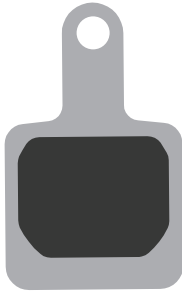

6875 - CARD

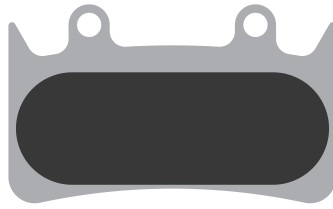

6876 - CARD

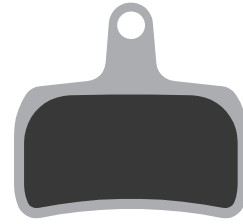

6877 - CARD



6878 - CARD

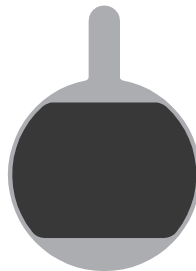

6879 - CARD

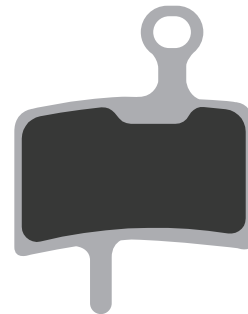

6880 - CARD



6881 - CARD

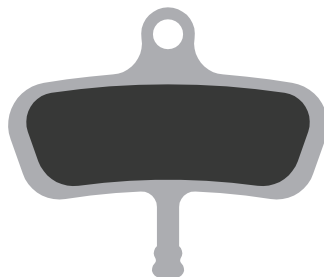

6882 - CARD

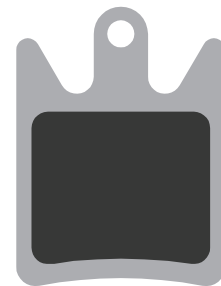

6883 - CARD

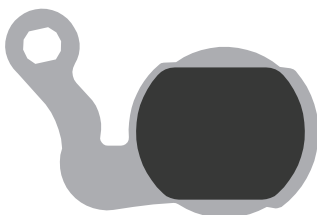

6884 - CARD  
6884 S - CARD



6885 - CARD



6886 - CARD  
6886 MC - CARD

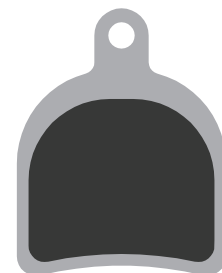

6887 - CARD

## BRAKE

- DISC BRAKE SYSTEMS
- CALIPER ADAPTERS
- DISC BRAKE ROTORS
- DISC BRAKE PARTS
- DISC BRAKE PADS**
- RIM BRAKE PADS

## CABLE

- INNER CABLES
- OUTER CABLES
- ATB/RACE CABLES
- CABLE KITS
- CABLE PARTS

## HYDRO

- ORIGINAL BRANDS
- HYDRO COMPONENTS
- SHIMANO HYDRO COMPONENTS
- O-RINGS

## ROTATION

- BEARINGS
- HEADSET BEARINGS
- HEADSET PARTS
- PULLEY WHEELS
- BOTTOM BRACKET GUIDE
- BOTTOM BRACKETS
- BOTTOM BRACKET PARTS

## TOOLS AND MAINTENANCE

- MAINTENANCE
- CABLE TOOLS
- MORE TOOLS
- HYDRO TOOLS
- BOTTOM BRACKET TOOLS

## WORKSHOP

- TRANSIT
- BOXER
- PARTNER
- CADDY
- PADFINDER
- DISCOVERY

# DISC BRAKE PADS

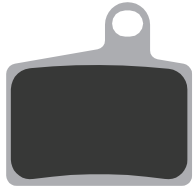

6888 - CARD  
6888 S - CARD

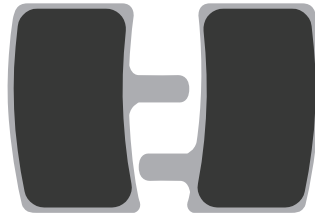

6889 - CARD  
6889 S - CARD

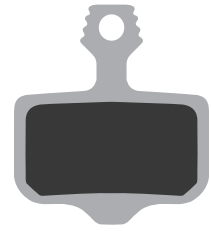

6890 - CARD / -BOX  
6890 S - CARD / -BOX  
6890 MC - CARD / -BOX

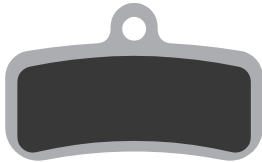

6891 - CARD  
6891 S - CARD  
6891 MC - CARD



6892 - CARD

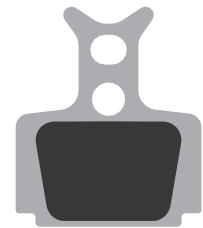

6893 - CARD  
6893 S - CARD  
6893 MC - CARD

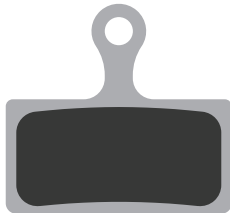

6894 - CARD / -BOX / -BOX25  
6894 S - CARD / -BOX / -BOX25  
6894 MC - CARD / -BOX / -BOX25

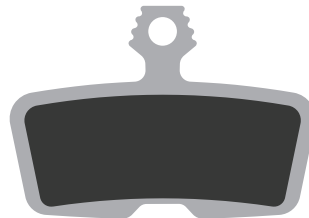

6895 - CARD  
6895 S - CARD  
6895 MC - CARD



6896 - CARD  
6896 S - CARD

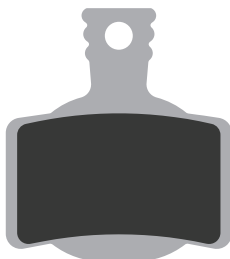

6897 - CARD / -BOX  
6897 S - CARD / -BOX  
6897 MC - CARD / -BOX



6898 - CARD / -BOX  
6898 S - CARD / -BOX  
6898 MC - CARD / -BOX

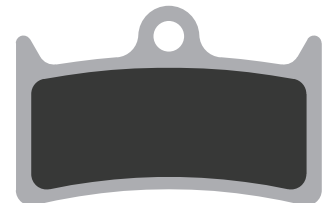

6899 - CARD  
6899 S - CARD

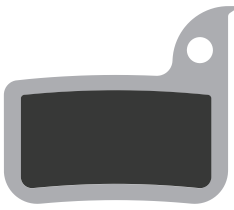

6900 - CARD / -BOX / -BOX25  
 6900 S - CARD / -BOX / -BOX25  
 6900 MC - CARD / -BOX / -BOX25

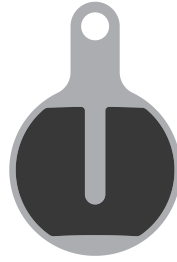

6901 - CARD

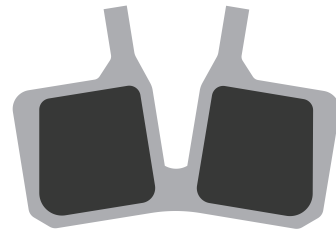

6902 - CARD / -BOX / -BOX25  
 6902 S - CARD / -BOX / -BOX25  
 6902 MC - CARD / -BOX / -BOX25

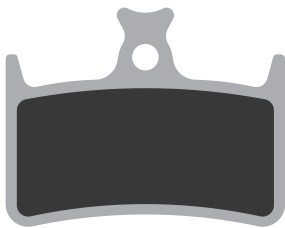

6903 - CARD



6904 - CARD

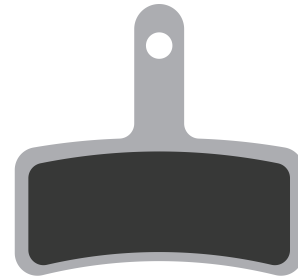

6905 - CARD

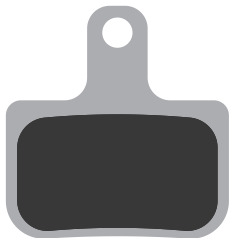

6906 - CARD / -BOX / -BOX25  
 6906 S - CARD / -BOX / -BOX25  
 6906 MC - CARD / -BOX / -BOX25

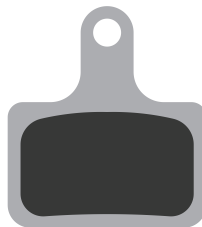

6907 - CARD / -BOX / -BOX25  
 6907 S - CARD  
 6907 MC - CARD

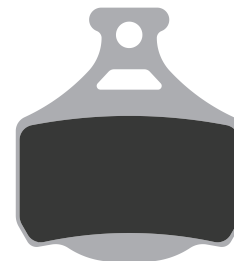

6908 - CARD

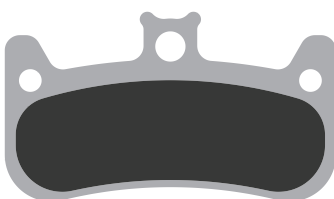

6909 - CARD  
 6909 S - CARD  
 6909 MC - CARD

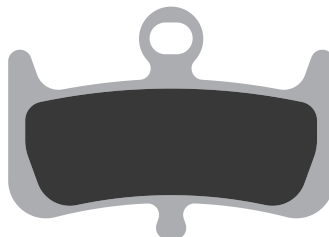

6910 - CARD  
 6910 S - CARD  
 6910 MC - CARD



6911 - CARD  
 6911 S - CARD  
 6911 MC - CARD

## BRAKE

- DISC BRAKE SYSTEMS
- CALIPER ADAPTERS
- DISC BRAKE ROTORS
- DISC BRAKE PARTS
- DISC BRAKE PADS
- RIM BRAKE PADS

## CABLE

- INNER CABLES
- OUTER CABLES
- ATB/RACE CABLES
- CABLE KITS
- CABLE PARTS

## HYDRO

- ORIGINAL BRANDS
- HYDRO COMPONENTS
- SHIMANO HYDRO COMPONENTS
- O-RINGS

## ROTATION

- BEARINGS
- HEADSET BEARINGS
- HEADSET PARTS
- PULLEY WHEELS
- BOTTOM BRACKET GUIDE
- BOTTOM BRACKETS
- BOTTOM BRACKET PARTS

## TOOLS AND MAINTENANCE

- MAINTENANCE
- CABLE TOOLS
- MORE TOOLS
- HYDRO TOOLS
- BOTTOM BRACKET TOOLS

## WORKSHOP

- TRANSIT
- BOXER
- PARTNER
- CADDY
- PADFINDER
- DISCOVERY

# RIM BRAKE PAD GUIDE

## ☀️ BLACK COMPOUND

- For steel and aluminium rims
- Developed for dry conditions
- Excellent for city bike / trekking bike / racing bike



## ☁️ BLACK/RED COMPOUND

- For steel and aluminium rims
- Developed for wet conditions
- Excellent for MTB



## ☀️ ☁️ 📢 WHITE COMPOUND

- For steel and aluminium rims
- For more brake power
- Developed for dry and wet conditions
- Excellent for E-bike / racing bike / BMX



## ☀️ ☁️ BLUE COMPOUND

- For carbon rims only
- Developed for dry and wet conditions
- Excellent for racing bike / BMX



## ORDER QUANTITY

### XXXX -CARD

All rim brake pads can be ordered per card, containing 1 pair.

### XXXX -BOX

Select rim brake pads can be ordered per box, containing 25 pairs.



### 6813

-CARD

Caliper

X-groove design



### 6843

-CARD

Caliper

X-groove design

More brake power  
Less noise



### 6814

-CARD / -BOX

Power pads

compatible with  
Magura HS11/33



### 6840

-CARD / -BOX

Power pads

compatible with  
Magura HS11/33

More brake power  
Less noise



### 6846

-CARD

Race

compatible with  
Campagnolo

55 mm cartridge



### 6836

-CARD

Race

compatible with  
Campagnolo

55 mm light weight cartridge

More brake power  
Less noise



### 6844

-CARD

Race

compatible with  
Campagnolo

55 mm light weight  
cartridge

For carbon rims only



### 6822

-CARD

Race

compatible with  
Campagnolo

55 mm replacement pad

6836, 6844, 6846



### 6838

-CARD

Race

compatible with  
Campagnolo

55 mm replacement pad

More brake power  
Less noise

6836, 6844, 6846



### 6826

-CARD

Race

compatible with  
Campagnolo

55 mm replacement pad

For carbon rims only

6836, 6844, 6846



## BRAKE

DISC BRAKE SYSTEMS

CALIPER ADAPTERS

DISC BRAKE ROTORS

DISC BRAKE PARTS

DISC BRAKE PADS

RIM BRAKE PADS

## CABLE

INNER CABLES

OUTER CABLES

ATB/RACE CABLES

CABLE KITS

CABLE PARTS

## HYDRO

ORIGINAL BRANDS

HYDRO  
COMPONENTS

SHIMANO HYDRO  
COMPONENTS

O-RINGS

## ROTATION

BEARINGS

HEADSET BEARINGS

HEADSET PARTS

PULLEY WHEELS

BOTTOM BRACKET  
GUIDE

BOTTOM BRACKETS

BOTTOM BRACKET  
PARTS

## TOOLS AND MAINTENANCE

MAINTENANCE

CABLE TOOLS

MORE TOOLS

HYDRO TOOLS

BOTTOM BRACKET  
TOOLS

## WORKSHOP

TRANSIT

BOXER

PARTNER

CADDY

PADFINDER

DISCOVERY

# RIM BRAKE PADS

## 6808

-CARD  
Cantilever  
70 mm symmetrical



## 6812

-BOX  
Cantilever  
72 mm



## 6833

-CARD  
Cantilever  
55 mm cartridge  
Cyclocross



## 6834

-CARD  
Cantilever  
55 mm replacement pad  
Cyclocross  
6833



## 6842

-CARD / -BOX  
Race  
compatible with Shimano  
55 mm



## 6848

-CARD  
Race  
compatible with Shimano  
55 mm  
More brake power  
Less noise



## 6847

-CARD  
Race  
compatible with Shimano  
55 mm



## 6835

-CARD  
Race  
compatible with Shimano  
55 mm light weight cartridge  
More brake power  
Less noise



## 6845

-CARD  
Race  
compatible with Shimano  
55 mm  
For carbon rims only



## 6810

-CARD / -BOX  
Race  
compatible with Shimano  
55 mm replacement pad



6835, 6845, 6847

## 6837

-CARD  
Race  
compatible with Shimano  
55 mm replacement pad  
More brake power  
Less noise  
6835, 6845, 6847



## 6827

-CARD  
Race  
compatible with Shimano  
55 mm replacement pad  
For carbon rims only  
6835, 6845, 6847

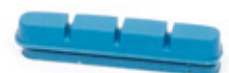

## 6807

-CARD / -BOX  
V-brake pads  
55 mm replacement pad



## 6816

-CARD / -BOX  
V-brake pads  
70 mm symmetrical



## 6806

-CARD / -BOX  
V-brake pads  
72 mm



## 6828

-BOX  
V-brake pads  
72 mm  
ABS design



## 6815

-CARD / -BOX  
V-brake pads  
72 mm  
Special groove design



## 6832

-CARD / -BOX  
V-brake pads  
72 mm  
More brake power  
Less noise



## 6804

-CARD  
V-brake pads  
72 mm cartridge



## 6802

-CARD  
V-brake pads  
72 mm cartridge  
Special groove design



## 6805

-CARD / -BOX  
V-brake pads  
72 mm replacement pad



## 6803

-CARD  
V-brake pads  
72 mm cartridge  
Special groove design



6802, 6804

6802, 6804

## 6841

-CARD  
V-brake pads  
72 mm replacement pad  
More brake power  
Less noise  
6802, 6804



## 6839

-CARD  
V-brake pads  
72 mm cartridge  
For carbon rims only



6802, 6804

## BRAKE

DISC BRAKE SYSTEMS  
CALIPER ADAPTERS  
DISC BRAKE ROTORS  
DISC BRAKE PARTS  
DISC BRAKE PADS  
RIM BRAKE PADS

## CABLE

INNER CABLES  
OUTER CABLES  
ATB/RACE CABLES  
CABLE KITS  
CABLE PARTS

## HYDRO

ORIGINAL BRANDS  
HYDRO COMPONENTS  
SHIMANO HYDRO COMPONENTS  
O-RINGS

## ROTATION

BEARINGS  
HEADSET BEARINGS  
HEADSET PARTS  
PULLEY WHEELS  
BOTTOM BRACKET GUIDE  
BOTTOM BRACKETS  
BOTTOM BRACKET PARTS

## TOOLS AND MAINTENANCE

MAINTENANCE  
CABLE TOOLS  
MORE TOOLS  
HYDRO TOOLS  
BOTTOM BRACKET TOOLS

## WORKSHOP

TRANSIT  
BOXER  
PARTNER  
CADDY  
PADFINDER  
DISCOVERY

CABLE





## VOLUME BOX

All inner cables are compatible with Shimano, SRAM and Campagnolo

**G** - Galvanised  
**S** - Stainless steel



**19 strands Regular**

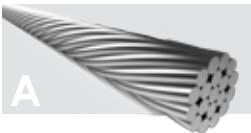

**19 strands slick Extra smooth**

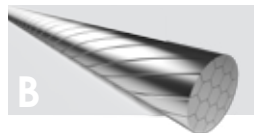

**49 (7x7) strands Extra flexible**

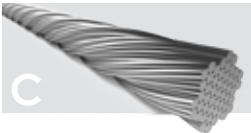

**49 (7x7) strands slick Extra flexible, extra smooth**

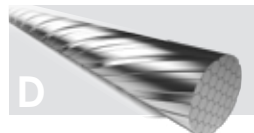

**31 strands slick Medium flexible, extra smooth**

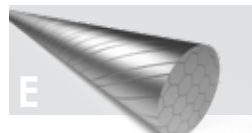

## BRAKE

6426RVS-BOX	S	2 000 mm	A	100 pcs
6426RVS-SLICK-BOX	S	2 000 mm	B	100 pcs
6427RVS-BOX	S	2 250 mm	A	100 pcs
6427RVS-SLICK-BOX	S	2 250 mm	B	100 pcs
6427RVS-49-BOX	S	2 250 mm	C	100 pcs
6427RVS-3M-BOX	S	3 000 mm	A	50 pcs

## BRAKE

6411RVS-BOX	S	2 000 mm	A	100 pcs
6411RVS-SLICK-BOX	S	2 000 mm	B	100 pcs
6411RVS-49-BOX	S	2 000 mm	C	100 pcs

## SHIFT

6472RVS-BOX	S	2 250 mm	A	100 pcs
6472RVS-SLICK-BOX	S	2 250 mm	B	100 pcs
6472RVS-49-BOX	S	2 250 mm	C	100 pcs
6472RVS-49-SLICK-BOX	S	2 250 mm	D	50 pcs
6472RVS-3M-BOX	S	3 000 mm	A	50 pcs

## SHIFT

Only compatible with Shimano and SRAM

6472RVS-SHIM-BOX	S	2 250 mm	A	100 pcs
6472RVS-SHIM-SL-BOX	S	2 250 mm	B	100 pcs
6472RVS-SH-49-SL-BOX	S	2 250 mm	D	50 pcs
2021056-BOX	S	2 250 mm	E	50 pcs

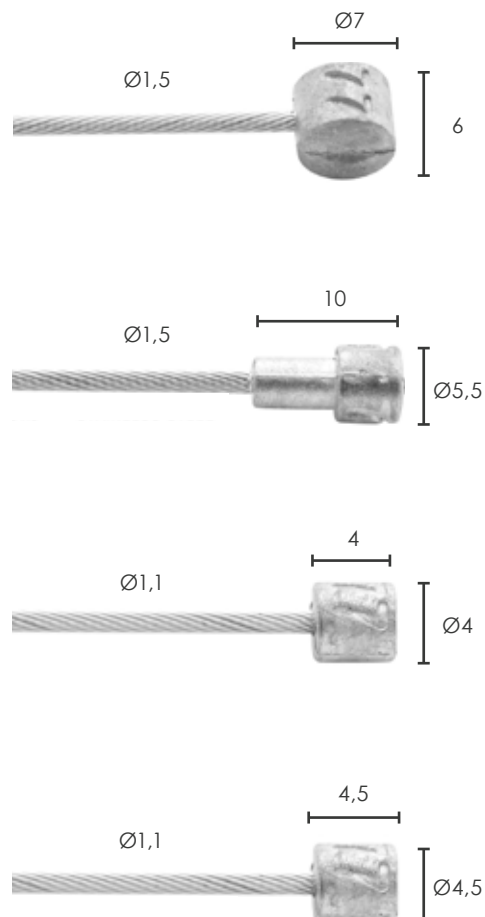

## BRAKE

DISC BRAKE SYSTEMS  
CALIPER ADAPTERS  
DISC BRAKE ROTORS  
DISC BRAKE PARTS  
DISC BRAKE PADS  
RIM BRAKE PADS

## CABLE

INNER CABLES  
OUTER CABLES  
ATB/RACE CABLES  
CABLE KITS  
CABLE PARTS

## HYDRO

ORIGINAL BRANDS  
HYDRO COMPONENTS  
SHIMANO HYDRO COMPONENTS  
O-RINGS

## ROTATION

BEARINGS  
HEADSET BEARINGS  
HEADSET PARTS  
PULLEY WHEELS  
BOTTOM BRACKET GUIDE  
BOTTOM BRACKETS  
BOTTOM BRACKET PARTS

## TOOLS AND MAINTENANCE

MAINTENANCE  
CABLE TOOLS  
MORE TOOLS  
HYDRO TOOLS  
BOTTOM BRACKET TOOLS

## WORKSHOP

TRANSIT  
BOXER  
PARTNER  
CADDY  
PADFINDER  
DISCOVERY

# INNER CABLES

## CARD

All inner cables are compatible with Shimano, SRAM and Campagnolo

Types of inner cables

- G** - Galvanised
- S** - Stainless steel



**19 strands Regular**

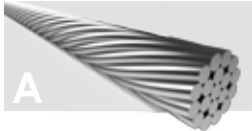

**19 strands slick Extra smooth**

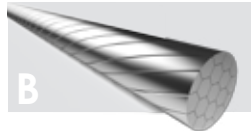

**49 (7x7) strands Extra flexible**

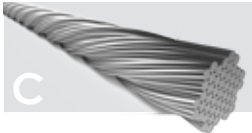

**49 (7x7) strands slick Extra flexible, extra smooth**

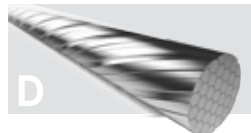

**31 strands slick Medium flexible, extra smooth**

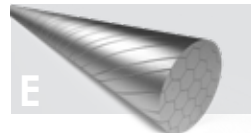

## BRAKE

6414	G	900 mm	A	20 pcs
6414RVS	S	1 000 mm	A	20 pcs
6416	G	1 250 mm	A	20 pcs
6416RVS	S	1 250 mm	A	20 pcs
6426	G	2 000 mm	A	20 pcs
6426RVS	S	2 000 mm	A	20 pcs
6426RVS-SLICK	S	2 000 mm	B	20 pcs
6427	G	2 250 mm	A	20 pcs
6427RVS	S	2 250 mm	A	20 pcs
6427RVS-SLICK	S	2 250 mm	B	20 pcs
6427RVS-49	S	2 250 mm	C	20 pcs
6427-3M	G	3 000 mm	A	15 pcs
6427RVS-3M	S	3 000 mm	A	15 pcs
6427RVS-5M	S	5 000 mm	A	10 pcs

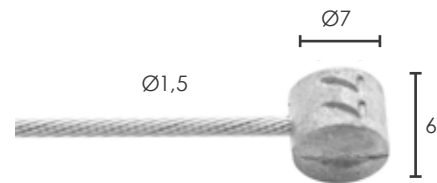

## BRAKE

6412/27	G	2 250 mm	A	20 pcs
6412/27RVS	S	2 350 mm	A	20 pcs
6412/27RVS-SLICK	S	2 350 mm	B	20 pcs
6412/27RVS-49	S	2 250 mm	C	20 pcs
6412/27RVS-3M	S	3 000 mm	A	15 pcs
6412/27-4M	G	4 000 mm	A	10 pcs
6412/27RVS-4M	S	4 000 mm	A	10 pcs

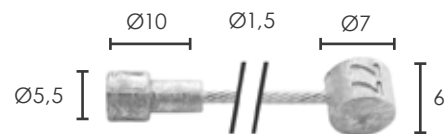

## BRAKE

6411	G	2 000 mm	A	20 pcs
6411RVS	S	2 000 mm	A	20 pcs
6411RVS-SLICK	S	2 000 mm	B	20 pcs
6412	G	2 250 mm	A	20 pcs
6412RVS	S	2 250 mm	A	20 pcs
6412RVS-SLICK	S	2 250 mm	B	20 pcs
6412-49	G	2 250 mm	C	20 pcs
6412RVS-49	S	2 250 mm	C	20 pcs

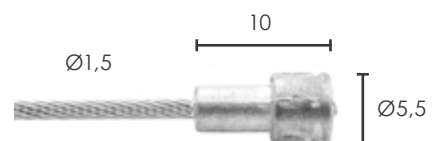

## SHIFT

Only compatible with Shimano and SRAM

6472RVS-SHIM	S	2 250 mm	A	20 pcs/carton
6472RVS-SHIM-SLICK	S	2 250 mm	B	20 pcs/carton
6472RVS-SHIM-49-SL	S	2 250 mm	D	20 pcs/carton
2020213	S	4 000 mm	D	15 pcs/carton
2021056	S	2 250 mm	E	20 pcs/carton
2021057	S	4 000 mm	E	15 pcs/carton

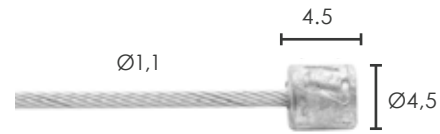

## SHIFT

6446	G	2 250 mm	A	20 pcs/carton
6446RVS	S	2 250 mm	A	20 pcs/carton

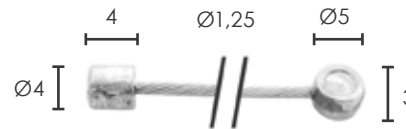

## SHIFT

6400	G	2 250 mm	A	20 pcs/carton
6400RVS	S	2 250 mm	A	20 pcs/carton
6400RVS-3M	S	3 000 mm	A	15 pcs/carton

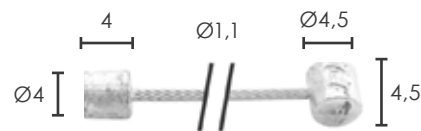

## SHIFT

6446-1	G	2 250 mm	A	20 pcs/carton
6472RVS	S	2 250 mm	A	20 pcs/carton
6472RVS-SLICK	S	2 250 mm	B	20 pcs/carton
6472RVS-3M	S	3 000 mm	A	20 pcs/carton
6472RVS-49	S	2 250 mm	C	20 pcs/carton
6472RVS-49-SLICK	S	2 250 mm	D	20 pcs/carton
6472RVS-4M	S	4 000 mm	A	15 pcs/carton
6472RVS-5M	S	5 000 mm	A	15 pcs/carton



## SHIFT

6451/72RVS	S	2 250 mm	A	20 pcs/carton
6451/72RVS-3M	S	3 000 mm	A	20 pcs/carton

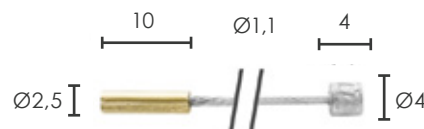

## SHIFT

6451/18	G	2 250 mm	A	20 pcs/carton
---------	---	----------	---	---------------

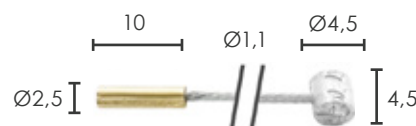

## BRAKE

- DISC BRAKE SYSTEMS
- CALIPER ADAPTERS
- DISC BRAKE ROTORS
- DISC BRAKE PARTS
- DISC BRAKE PADS
- RIM BRAKE PADS

## CABLE

- INNER CABLES
- OUTER CABLES
- ATB/RACE CABLES
- CABLE KITS
- CABLE PARTS

## HYDRO

- ORIGINAL BRANDS
- HYDRO COMPONENTS
- SHIMANO HYDRO COMPONENTS
- O-RINGS

## ROTATION

- BEARINGS
- HEADSET BEARINGS
- HEADSET PARTS
- PULLEY WHEELS
- BOTTOM BRACKET GUIDE
- BOTTOM BRACKETS
- BOTTOM BRACKET PARTS

## TOOLS AND MAINTENANCE

- MAINTENANCE
- CABLE TOOLS
- MORE TOOLS
- HYDRO TOOLS
- BOTTOM BRACKET TOOLS

## WORKSHOP

- TRANSIT
- BOXER
- PARTNER
- CADDY
- PADFINDER
- DISCOVERY

# OUTER CABLES

## VOLUME BOX

All Elvedes outer cables have MoS<sub>2</sub> enriched liner for lower friction and higher performance.

The outer cable volume boxes come with an easy pull reel made of 100% recycled and 100% recyclable plastic.

The boxes are also equipped with a unique GripClip, which prevents the outer cable from slipping back into the box after cutting.



The cable type is indicated by the letter A, B, C or D

Brake cable



Braided brake cable



Shift cable



Braided shift / brake cable



### SHIFT Ø4,1

Box 30m	Bag 10m	Colour
1120SP-1-BOX	1120SP-1-10	C Black
1120SP-3-BOX	1120SP-3-10	C Silver
1120SP-6-BOX	1120SP-6-10	C White
1120SP-7-BOX	1120SP-7-10	C Red
1120SP-8-BOX	1120SP-8-10	C Blue
1120SP-9-BOX	1120SP-9-10	C Orange
1120SP-10-BOX	1120SP-10-10	C Green
1120SP-11-BOX	1120SP-11-10	C Neon orange
1120SP-12-BOX	1120SP-12-10	C Neon yellow
1120SP-13-BOX	1120SP-13-10	C Neon green
1120SP-14-BOX	1120SP-14-10	C Yellow
1120SP-15-BOX	1120SP-15-10	C Pink
2019089-BOX	2019089-10	C Brown
2019091-BOX	2019091-10	C Celeste

### SHIFT Ø4,9

Box 30m	Bag 10m	Colour
1125SP-1-BOX	1125SP-1-10	C Black
1125SP-3-BOX	1125SP-3-10	C Silver
182041-BOX	182041-10	D Silver
182042-BOX	182042-10	D Smoke silver
182043-BOX	182043-10	D Titanium

### BRAKE Ø4,9

Box 30m	Bag 10m	Colour
1125-BOX	1125-10	- Black
1125TEF-1-BOX	1125TEF-1-10	A Black
1125TEF-2-BOX	1125TEF-2-10	A Grey
1125TEF-3-BOX	1125TEF-3-10	A Silver
1125TEF-6-BOX	1125TEF-6-10	A White
1125TEF-7-BOX	1125TEF-7-10	A Red
1125TEF-8-BOX	1125TEF-8-10	A Blue
1125TEF-9-BOX	1125TEF-9-10	A Orange
1125TEF-10-BOX	1125TEF-10-10	A Green
1125TEF-11-BOX	1125TEF-11-10	A Neon orange
1125TEF-12-BOX	1125TEF-12-10	A Neon yellow
1125TEF-13-BOX	1125TEF-13-10	A Neon green
1125TEF-14-BOX	1125TEF-14-10	A Yellow
1125TEF-15-BOX	1125TEF-15-10	A Pink
2019088-BOX	2019088-10	A Brown
2019090-BOX	2019090-10	A Celeste
1125LSR-6-BOX	1125LSR-6-10	A Black/chrome
1125LSR-7-BOX	1125LSR-7-10	A Chrome
182038-BOX	182038-10	B Silver
182039-BOX	182039-10	B Smoke silver
182040-BOX	182040-10	B Titanium

### BRAKE AND SHIFT Ø4,9

Box 30m	Bag 10m	Colour
2010016-BOX	2010016-10	D Carbon
2020256-BOX	2020256-10	D Black

Linear outer cable for powerful braking and precise shifting. Excellent for cargo bikes, tandems and mechanical disc brakes.

## CABLE KIT

All cable kits fit Shimano, Campagnolo and SRAM

### 19 strands regular

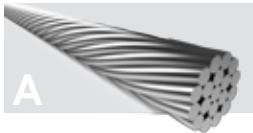

### 49 (7x7) strands slick Extra flexible, extra smooth

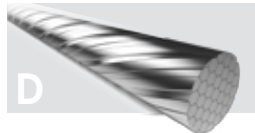

## BRAKE

- DISC BRAKE SYSTEMS
- CALIPER ADAPTERS
- DISC BRAKE ROTORS
- DISC BRAKE PARTS
- DISC BRAKE PADS
- RIM BRAKE PADS

## CABLE

- INNER CABLES
- OUTER CABLES
- ATB/RACE CABLES
- CABLE KITS
- CABLE PARTS

## BRAKE CABLE KIT

fits MTB and road systems

2015009	A	Black	
2015010	A	Silver	
2015011	A	White	
2015012	A	Red	
2015013	A	Blue	
2015014	A	Orange	
2015015	A	Green	
2017150	A	Pink	
2017152	A	Yellow	

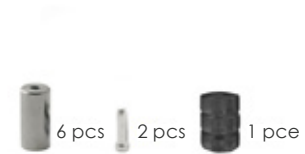
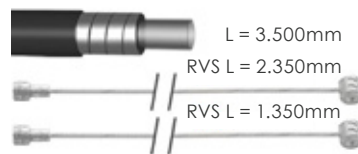

## HYDRO

- ORIGINAL BRANDS
- HYDRO COMPONENTS
- SHIMANO HYDRO COMPONENTS
- O-RINGS

## SHIFT CABLE KIT

fits MTB and road systems

2015002	A	Black	
2015003	A	Silver	
2015004	A	White	
2015005	A	Red	
2015006	A	Blue	
2015007	A	Orange	
2015008	A	Green	
2017151	A	Pink	
2017153	A	Yellow	

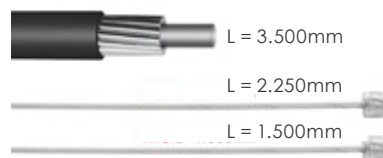

## ROTATION

- BEARINGS
- HEADSET BEARINGS
- HEADSET PARTS
- PULLEY WHEELS
- BOTTOM BRACKET GUIDE
- BOTTOM BRACKETS
- BOTTOM BRACKET PARTS

## 1X SHIFT CABLE KIT

2021040	D	Black	
---------	---	-------	--

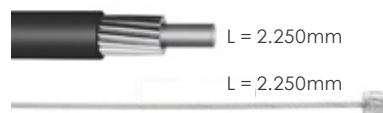

## TOOLS AND MAINTENANCE

- MAINTENANCE
- CABLE TOOLS
- MORE TOOLS
- HYDRO TOOLS
- BOTTOM BRACKET TOOLS

## SHIFT OT-RS900

2021073	240 mm	Black	1 pce/bag, 15 bags/carton
2021074	240 mm	Black	10 pcs/bag, 15 bags/carton



## WORKSHOP

- TRANSIT
- BOXER
- PARTNER
- CADDY
- PADFINDER
- DISCOVERY

# CABLE KITS

## CARD

All cable kits are available per card.  
Cards per carton are mentioned per item no.

Types of inner cables

- G** - Galvanised
- S** - Stainless steel



## BRAKE

2021071 1 800 mm Black 15 pcs/carton



## SHIFT

2021072 2 000 mm Black 15 pcs/carton



## DRUMBRAKE

6473 G 2 250 mm 14 pcs/carton

6473RVS S 2 350 mm 14 pcs/carton

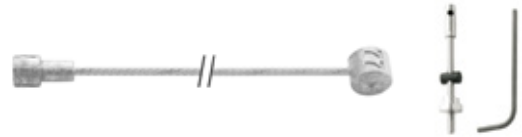

## DRUMBRAKE

6269SP G 1 800 mm 2 250 mm Black 15 pcs/carton

6269SP-RVS S 1 800 mm 2 350 mm Black 15 pcs/carton

6269SP-3 S 1 800 mm 2 350 mm Silver 15 pcs/carton



## DRUMBRAKE

6268SP G 1 100 mm 1 250 mm Black 15 pcs/carton

6268SP-RVS S 1 100 mm 1 350 mm Black 15 pcs/carton

6268SP-3 S 1 100 mm 1 350 mm Silver 15 pcs/carton

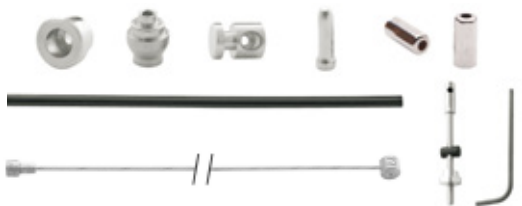

## BRAKE UNIVERSAL

6445 G 1 800 mm 2 250 mm Black 15 pcs/carton

6445RVS S 1 800 mm 2 350 mm Black 15 pcs/carton

6445-3 S 1 800 mm 2 350 mm Silver 15 pcs/carton



## BRAKE 2 NIPLLES

6444/39 G 1 800 mm 2 250 mm Black 15 pcs/carton

6444/39-RVS S 1 800 mm 2 350 mm Black 15 pcs/carton



## BRAKE

6439 G 1 800 mm 2 000 mm Black 15 pcs/carton

## BRAKE

6436 G 540 mm 900 mm Black 15 pcs/carton  
 6436RVS S 540 mm 900 mm Black 15 pcs/carton  
 6444 G 1 800 mm 2 000 mm Black 15 pcs/carton  
 6444RVS S 1 800 mm 2 000 mm Black 15 pcs/carton

## ROLLERBRAKE BR-IM45/55/80/81/85

2012025 S 1 100 mm 1 250 mm Black 15 pcs/carton  
 2012026 S 1 100 mm 1 250 mm Silver 15 pcs/carton  
 2012027 S 1 800 mm 2 250 mm Black 15 pcs/carton  
 2012028 S 1 800 mm 2 250 mm Silver 15 pcs/carton

## ROLLERBRAKE BR-IM41/50/53

6282 S 1 100 mm 1 250 mm Black 15 pcs/carton  
 6283 S 1 800 mm 2 250 mm Black 15 pcs/carton  
 6284 S 1 100 mm 1 250 mm Silver 15 pcs/carton  
 6285 S 1 800 mm 2 250 mm Silver 15 pcs/carton

## SHIFT STURMEY ARCHER UNIVERSAL

6478 G 1 800 mm 2 250 mm Black 15 pcs/carton  
 6478-3 S 1 800 mm 2 250 mm Silver 15 pcs/carton

## NEXUS 4/7/8 SPEED

6286 S 2 000 mm 2 250 mm Black 15 pcs/carton  
 6287 S 2 000 mm 2 250 mm Silver 15 pcs/carton

## SHIFT FOR ALL DERAILLEURS + NEXUS 3 SPEED

6479 S 2 000 mm 2 250 mm Black 15 pcs/carton  
 6479-3 S 2 000 mm 2 250 mm Silver 15 pcs/carton

## SHIFT SRAM UNIVERSAL

6477 G 1 800 mm 2 250 mm Black 15 pcs/carton



## BRAKE

DISC BRAKE SYSTEMS  
 CALIPER ADAPTERS  
 DISC BRAKE ROTORS  
 DISC BRAKE PARTS  
 DISC BRAKE PADS  
 RIM BRAKE PADS

## CABLE

INNER CABLES  
 OUTER CABLES  
 ATB/RACE CABLES  
 CABLE KITS  
 CABLE PARTS

## HYDRO

ORIGINAL BRANDS  
 HYDRO COMPONENTS  
 SHIMANO HYDRO COMPONENTS  
 O-RINGS

## ROTATION

BEARINGS  
 HEADSET BEARINGS  
 HEADSET PARTS  
 PULLEY WHEELS  
 BOTTOM BRACKET GUIDE  
 BOTTOM BRACKETS  
 BOTTOM BRACKET PARTS

## TOOLS AND MAINTENANCE

MAINTENANCE  
 CABLE TOOLS  
 MORE TOOLS  
 HYDRO TOOLS  
 BOTTOM BRACKET TOOLS

## WORKSHOP

TRANSIT  
 BOXER  
 PARTNER  
 CADDY  
 PADFINDER  
 DISCOVERY

# CABLE KITS

## CABLE KIT DROPPER-POST AND LOCK-OUT REMOTES

(excl. remote)  
2021081

L = 2.000mm



49 (7x7) strands slick  
Extra flexible, extra smooth



## FREESTYLE CABLE REAR

6489 1 pce



## FREESTYLE CABLE FRONT

6484 1 pce

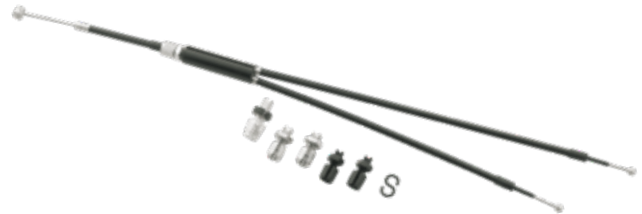

## REPLACEMENT INNER CABLE (UPPER)

for universal cable splitter  
6412/27RVS/1.35 Stainless 1 350 mm 20 pcs/carton

1x19 strands regular

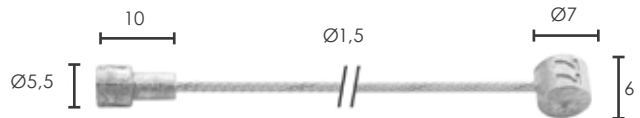
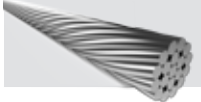

## REPLACEMENT INNER CABLE (LOWER)

for universal cable splitter  
2017145 Stainless 3 000 mm 15 pcs/carton

49 (7x7) strands extra flexible

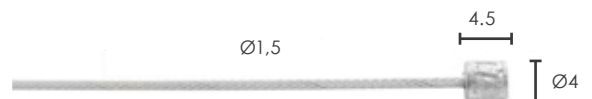
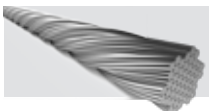



## UNIVERSAL CABLE SPLITTER SET

2017161

Operates 2 brakes with 1 brake lever.

Includes a unique part (D) to add an optional ABS function.

Easy and quick assembly.

Inner cables included.  
Outer cables not included.

- A Body
- B Cap
- C Piston
- D ABS insert
- E O-ring
- F M3 fixing bolt
- G Allen key



- BRAKE**
- DISC BRAKE SYSTEMS
- CALIPER ADAPTERS
- DISC BRAKE ROTORS
- DISC BRAKE PARTS
- DISC BRAKE PADS
- RIM BRAKE PADS

- CABLE**
- INNER CABLES
- OUTER CABLES
- ATB/RACE CABLES
- CABLE KITS
- CABLE PARTS

- HYDRO**
- ORIGINAL BRANDS
- HYDRO COMPONENTS
- SHIMANO HYDRO COMPONENTS
- O-RINGS

- ROTATION**
- BEARINGS
- HEADSET BEARINGS
- HEADSET PARTS
- PULLEY WHEELS
- BOTTOM BRACKET GUIDE
- BOTTOM BRACKETS
- BOTTOM BRACKET PARTS

- TOOLS AND MAINTENANCE**
- MAINTENANCE
- CABLE TOOLS
- MORE TOOLS
- HYDRO TOOLS
- BOTTOM BRACKET TOOLS

- WORKSHOP**
- TRANSIT
- BOXER
- PARTNER
- CADDY
- PADFINDER
- DISCOVERY

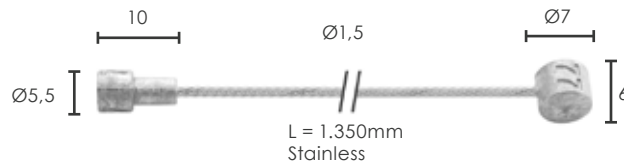

1x19 strands regular

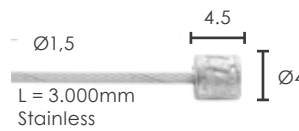
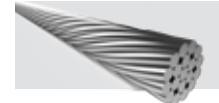

49 (7x7) strands extra flexible

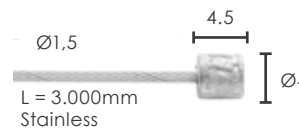
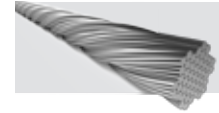

49 (7x7) strands extra flexible

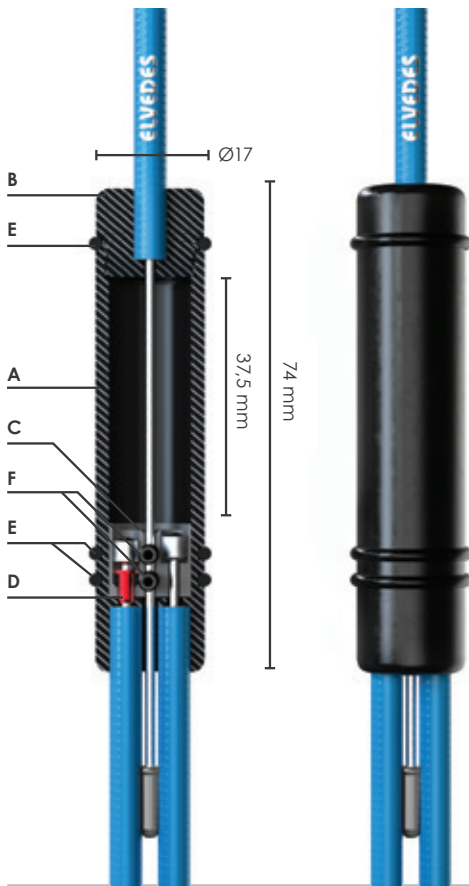
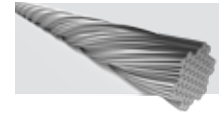

Scan this code for instructions



## ASSORTMENT BOX COLOURED FERRULES AND END CAPS

2012020

For consumer packaging: CPxxxx  
For workshop packaging: ELVxxxx

Contains:  
100 aluminium end caps of each colour  
25 aluminium ferrules of each size/colour



### ELV2012001

Ferrule with seal  
Ø5,0 mm  
Aluminium  
50 pcs



CP2012001 10 pcs

### ELV2012007

Ferrule with seal  
Ø4,3 mm  
Aluminium  
50 pcs



CP2012007 10 pcs

### ELV1171

End cap  
Ø2,3 mm  
Aluminium  
500 pcs



CP1171 10 pcs

### ELV2012002

Ferrule with seal  
Ø5,0 mm  
Aluminium  
50 pcs



CP2012002 10 pcs

### ELV2012008

Ferrule with seal  
Ø4,3 mm  
Aluminium  
50 pcs



CP2012008 10 pcs

### ELV2012013

End cap  
Ø2,3 mm  
Aluminium  
500 pcs



CP2012013 10 pcs

### ELV2012004

Ferrule with seal  
Ø5,0 mm  
Aluminium  
50 pcs



CP2012004 10 pcs

### ELV2012010

Ferrule with seal  
Ø4,3 mm  
Aluminium  
50 pcs



CP2012010 10 pcs

### ELV2012015

End cap  
Ø2,3 mm  
Aluminium  
500 pcs



CP2012015 10 pcs

### ELV2012003

Ferrule with seal  
Ø5,0 mm  
Aluminium  
50 pcs



CP2012003 10 pcs

### ELV2012009

Ferrule with seal  
Ø4,3 mm  
Aluminium  
50 pcs



CP2012009 10 pcs

### ELV2012014

End cap  
Ø2,3 mm  
Aluminium  
500 pcs



CP2012014 10 pcs

### ELV2012006

Ferrule with seal  
Ø5,0 mm  
Aluminium  
50 pcs



CP2012006 10 pcs

### ELV2012012

Ferrule with seal  
Ø4,3 mm  
Aluminium  
50 pcs



CP2012012 10 pcs

### ELV2012017

End cap  
Ø2,3 mm  
Aluminium  
500 pcs



CP2012017 10 pcs

### ELV2012005

Ferrule with seal  
Ø5,0 mm  
Aluminium  
50 pcs



CP2012005 10 pcs

### ELV2012011

Ferrule with seal  
Ø4,3 mm  
Aluminium  
50 pcs



CP2012011 10 pcs

### ELV2012016

End cap  
Ø2,3 mm  
Aluminium  
500 pcs



CP2012016 10 pcs

## ALL PARTS AVAILABLE IN CONSUMER AND WORKSHOP PACKAGING

For consumer packaging: CPxxxx  
For workshop packaging: ELVxxxx

### ELV2016108

Ferrule

Ø4,3 to Ø4,75 mm  
Brass  
150 pcs



### ELV2016107

Ferrule

Ø4,3 to Ø5,7 mm  
Brass  
150 pcs



CP2016107

10 pcs

### ELV1160PRESSED

Ferrule

Ø5,0 mm  
Brass  
200 pcs



### ELV1160

Ferrule CNC

Ø5,0 mm  
Brass  
200 pcs



CP1160

10 pcs

### ELV1167

Ferrule push fit

Ø5,0 mm  
Brass  
200 pcs



### ELV1130

Ferrule S.A.

Ø5,0 mm  
Brass  
50 pcs



### ELV1001

Ferrule Weinmann

Ø5,5 mm  
Aluminium  
100 pcs



### ELV1161

Ferrule with seal

Ø4,3 mm  
Brass  
100 pcs



### ELV2015057

Ferrule with seal

Ø4,3 mm  
PA6  
100 pcs



### ELV1160PVC4-1

Ferrule

Ø4,3 mm  
PA6  
150 pcs



CP1160PVC4-1

10 pcs

### ELV1160PVC4-3

Ferrule

Ø4,3 mm  
PA6  
150 pcs



### ELV1160PVC5-1

Ferrule

Ø5,0 mm  
PA6  
150 pcs



CP1160PVC5-1

10 pcs

### ELV1160PVC5-3

Ferrule

Ø5,0 mm  
PA6  
150 pcs



### ELV2012107

Ferrule with tip

Ø4,3 mm  
PA6  
50 pcs



### ELV2012106

Ferrule with tip

Ø5 mm  
PA6  
50 pcs



### ELV2018038

Ferrule with tip incl. rubber boot

Ø4,3 mm  
PA6  
25 pcs



### ELV1071

Adjuster

M5  
Brass  
15 pcs



### ELV1072

Adjuster

M6  
Brass  
15 pcs



## BRAKE

DISC BRAKE SYSTEMS  
CALIPER ADAPTERS  
DISC BRAKE ROTORS  
DISC BRAKE PARTS  
DISC BRAKE PADS  
RIM BRAKE PADS

## CABLE

INNER CABLES  
OUTER CABLES  
ATB/RACE CABLES  
CABLE KITS  
CABLE PARTS

## HYDRO

ORIGINAL BRANDS  
HYDRO COMPONENTS  
SHIMANO HYDRO COMPONENTS  
O-RINGS

## ROTATION

BEARINGS  
HEADSET BEARINGS  
HEADSET PARTS  
PULLEY WHEELS  
BOTTOM BRACKET GUIDE  
BOTTOM BRACKETS  
BOTTOM BRACKET PARTS

## TOOLS AND MAINTENANCE

MAINTENANCE  
CABLE TOOLS  
MORE TOOLS  
HYDRO TOOLS  
BOTTOM BRACKET TOOLS

## WORKSHOP

TRANSIT  
BOXER  
PARTNER  
CADDY  
PADFINDER  
DISCOVERY

# CABLE PARTS

## ALL PARTS AVAILABLE IN CONSUMER AND WORKSHOP PACKAGING

For consumer packaging: CPxxxx  
For workshop packaging: ELVxxxx

### ELV1090

Adjuster  
M6  
Aluminium  
25 pcs



### ELV2015139

Adjuster barrel  
Ø4,3 mm  
Steel  
15 pcs



CP2015139 2 pcs

### ELV2015140

Adjuster barrel  
Ø4,3 mm  
Aluminium  
15 pcs



CP2015140 2 pcs

### ELV1073

Adjuster for cable  
M6  
Brass  
10 pcs



### ELV2020100

Adjuster for lever  
M7  
Aluminium  
15 pcs



### ELV2020099

Adjuster for lever  
M10  
Aluminium  
15 pcs



### ELV2011003

Adjuster for rollerbrake  
M6  
Brass  
15 pcs



### ELV2014062

Adjuster inline  
Ø4,3 mm  
Aluminium  
15 pcs



CP2014062 2 pcs

### ELV2015173

Adjuster inline  
Ø5,0 mm  
Aluminium  
15 pcs



CP2015173 2 pcs

### ELV2011004

Cable bolt for Nexus  
4/7/8 speed  
Brass  
15 pcs



### ELV2011002

Cable bolt for rollerbrake  
BR-IM41/50/53  
Brass  
15 pcs



### ELV2012024

Cable bolt for rollerbrake  
BR-IM85/81/  
80/55/45  
Brass  
15 pcs



### ELV2012023

E-cap  
Fits 2012024  
POM  
25 pcs



### ELV1140

Cable bolt N-type  
Ø7 × 10 mm  
Brass  
50 pcs



### ELV1144

Cable bolt N-type  
Ø8 × 14 mm  
Brass  
50 pcs



### ELV1141

Cable bolt T-type  
Ø5 × 7 mm  
Brass  
50 pcs



### ELV1142

Cable bolt T-type  
Ø6 × 14 mm  
Brass  
50 pcs



### ELV1143

Cable bolt T-type  
Ø8 × 15 mm  
Brass  
25 pcs



## ELV6482/73

Linkwire  
73 mm  
Steel  
10 pcs



## ELV6482/82

Linkwire  
82 mm  
Steel  
10 pcs



## ELV6482/93

Linkwire  
93 mm  
Steel  
10 pcs



## ELV6482/106

Linkwire  
106 mm  
Steel  
10 pcs



## ELV1178

Open end cap  
Ø5,0 mm  
Aluminium  
25 pcs



## ELV1174

O-ring brake/shift  
Ø1,1 - 1,5 mm  
Rubber  
250 pcs



## ELV201211

Rubber boot  
0,8 - 1,2 mm  
Rubber  
15 pcs



## ELV1163

Rubber boot for V-brake  
35 mm  
Rubber  
15 pcs



## ELV2015143

Rubber boot for V-brake  
35 mm  
Rubber  
15 pcs



## ELV9009

Tensioner drumbrake universal  
M4,5  
Brass  
10 pcs



## ELV4545

Tensioner S.A. universal  
25 mm  
Brass  
15 pcs



## ELV5050

Tensioner SRAM T3  
Ø1,5 mm  
PA-GF  
10 pcs



## CP2019094

V-brake pipe 90° adjustable  
Ø5,0 mm  
Stainless steel  
2 pcs



## CP2019230

V-brake pipe 90° adjustable, short  
Ø5,0 mm  
Stainless steel  
2 pcs



## ELV2018061

V-brake pipe 90° black  
Ø5,0 mm  
Stainless steel  
10 pcs



## ELV1162-90

V-brake pipe 90°  
Ø5,0 mm  
Stainless steel  
10 pcs



## ELV1162-110

V-brake pipe 110°  
Ø5,0 mm  
Stainless steel  
10 pcs



## ELV1162-130

V-brake pipe 130°  
Ø5,0 mm  
Stainless steel  
10 pcs



## ELV1162

V-brake pipe flex  
Ø5,0 mm  
Stainless steel  
10 pcs



## ELV2012032

V-brake pipe flex incl. rubber boot  
Ø5,0 mm  
Stainless steel  
10 pcs



CP2012032 1 pce

## CP2017093

V-brake pipe flex, adjustable  
Ø5,0 mm  
Aluminium  
2 pcs



### BRAKE

DISC BRAKE SYSTEMS  
CALIPER ADAPTERS  
DISC BRAKE ROTORS  
DISC BRAKE PARTS  
DISC BRAKE PADS  
RIM BRAKE PADS

### CABLE

INNER CABLES  
OUTER CABLES  
ATB/RACE CABLES  
CABLE KITS  
CABLE PARTS

### HYDRO

ORIGINAL BRANDS  
HYDRO COMPONENTS  
SHIMANO HYDRO COMPONENTS  
O-RINGS

### ROTATION

BEARINGS  
HEADSET BEARINGS  
HEADSET PARTS  
PULLEY WHEELS  
BOTTOM BRACKET GUIDE  
BOTTOM BRACKETS  
BOTTOM BRACKET PARTS

### TOOLS AND MAINTENANCE

MAINTENANCE  
CABLE TOOLS  
MORE TOOLS  
HYDRO TOOLS  
BOTTOM BRACKET TOOLS

### WORKSHOP

TRANSIT  
BOXER  
PARTNER  
CADDY  
PADFINDER  
DISCOVERY

# CABLE PARTS

## ALL PARTS AVAILABLE IN CONSUMER AND WORKSHOP PACKAGING

For consumer packaging: CPxxxx  
For workshop packaging: ELVxxxx

### ELV2020102

Cable clip duo  
4,1 + 4,1 mm  
PA6  
50 pcs



CP2020102

10 pcs

### ELV2020101

Cable clip duo  
5,0 + 2,5 mm (Di2)  
PA6  
50 pcs



CP2020101

10 pcs

### ELV2020103

Cable clip duo  
5,0 + 4,1 mm  
PA6  
50 pcs



CP2020103

10 pcs

### ELV2020104

Cable clip duo  
5,0 + 5,0 mm  
PA6  
50 pcs



CP2020104

10 pcs

### ELV1075

Cable clip  
Ø5,0 mm  
PP  
20 pcs



### ELV2015142

Cable clip for frame notch  
Ø5,0 mm  
50 pcs



CP2015142

2 pcs

### ELV2015141

Cable clip rotating  
Ø4,3 - 5,0 mm  
50 pcs



CP2015141

4 pcs

### CP2019093

Cable guide pipe short  
Ø5,0 mm  
Aluminium  
2 pcs



### CP2015144

Cable hanger for cyclo-cross  
Aluminium  
1 pce



### ELV6464

Cantilever cable  
Ø1,5 mm  
extra flexible  
Stainless steel  
20 pcs



### ELV2019095

Cantilever cable bolt  
Brass  
10 pcs



### 2010015

Dual brake lever with parking stop  
Ø23 mm  
Steel  
1 pce



### ELV1171

End cap  
Ø2,3 mm  
Aluminium  
500 pcs



CP1171

10 pcs

### ELV1172

End cap  
Ø1,6 mm  
Aluminium  
500 pcs



CP1172

10 pcs

### ELV2018036

Extension ferrule  
Ø4,3 mm  
Aluminium  
25 pcs



### ELV2018035

Extension ferrule  
Ø5,0 mm  
Aluminium  
25 pcs



### ELV1176

Frame protector  
Ø4,3 - 5,0 mm  
Rubber  
25 pcs



### ELV2011001

Frame protector  
Ø4,3 - 5,0 mm  
Rubber  
25 pcs



CP2011001

4 pcs

## CABLE LINER

2016116

Ø2.0 / 2.6 mm  
L= 25mtr  
HDPE



## CABLE LINER WITH TRUMPET

2018099

Ø2.5 / 2.0 mm  
L= 300mm  
HDPE  
10 pcs



2018100

Ø2.5 / 2.0 mm  
L= 1.000mm  
HDPE  
10 pcs



## INNER LINER BRAKE

2018098

Ø2.5/2.0mm  
L=1.000mm  
HDPE Liner + ferrule  
2 pcs

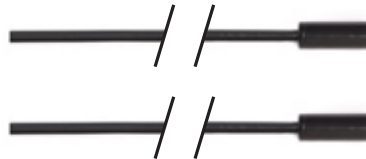

## INNER LINER SHIFT

2018097

Ø2.0/1.4mm  
L=750mm  
HDPE Liner + ferrule  
2 pcs



## ANTI-RATTLE FOAM

2018015

Ø11.0/6.0mm  
L=750mm  
10 pcs in sealbag  
Foam to prevent rattling  
internal cables and hoses



## SPIRAL WRAP TUBE

10 meter

2018031	Ø4mm	bundles 3-8 mm
2018032	Ø6mm	bundles 5-10 mm
2018033	Ø12mm	bundles 9-65 mm
2018034	Ø15mm	bundles 12-70 mm



## BRAKE

- DISC BRAKE SYSTEMS
- CALIPER ADAPTERS
- DISC BRAKE ROTORS
- DISC BRAKE PARTS
- DISC BRAKE PADS
- RIM BRAKE PADS

## CABLE

- INNER CABLES
- OUTER CABLES
- ATB/RACE CABLES
- CABLE KITS
- CABLE PARTS

## HYDRO

- ORIGINAL BRANDS
- HYDRO COMPONENTS
- SHIMANO HYDRO COMPONENTS
- O-RINGS

## ROTATION

- BEARINGS
- HEADSET BEARINGS
- HEADSET PARTS
- PULLEY WHEELS
- BOTTOM BRACKET GUIDE
- BOTTOM BRACKETS
- BOTTOM BRACKET PARTS

## TOOLS AND MAINTENANCE

- MAINTENANCE
- CABLE TOOLS
- MORE TOOLS
- HYDRO TOOLS
- BOTTOM BRACKET TOOLS

## WORKSHOP

- TRANSIT
- BOXER
- PARTNER
- CADDY
- PADFINDER
- DISCOVERY

HYDRO





## ORIGINAL BRAND HOSE EXTENSION SET

Extend original brand hydro hoses with fitting sets per brand. Packed in a sealbag.

### ELV2020240

6 pcs extension nipples  
12 pcs compression bolts  
Fits any original hose  
Use with compatible fittings



### 2019101

Shimano  
SM-BH59 and SM-BH90



### 2019102

Magura



### 2019103

SRAM / Avid



### 2019104

Tektro



### 2019105

Formula



### 2019106

Hayes



## BRAKE

- DISC BRAKE SYSTEMS
- CALIPER ADAPTERS
- DISC BRAKE ROTORS
- DISC BRAKE PARTS
- DISC BRAKE PADS
- RIM BRAKE PADS

## CABLE

- INNER CABLES
- OUTER CABLES
- ATB/RACE CABLES
- CABLE KITS
- CABLE PARTS

## HYDRO

- ORIGINAL BRANDS
- HYDRO COMPONENTS
- SHIMANO HYDRO COMPONENTS
- O-RINGS

## ROTATION

- BEARINGS
- HEADSET BEARINGS
- HEADSET PARTS
- PULLEY WHEELS
- BOTTOM BRACKET GUIDE
- BOTTOM BRACKETS
- BOTTOM BRACKET PARTS

## TOOLS AND MAINTENANCE

- MAINTENANCE
- CABLE TOOLS
- MORE TOOLS
- HYDRO TOOLS
- BOTTOM BRACKET TOOLS

## WORKSHOP

- TRANSIT
- BOXER
- PARTNER
- CADDY
- PADFINDER
- DISCOVERY

## ASSORTMENT BOX ORIGINAL BRAND HOSE FITTINGS

2015145

With this box, any original hose of Tektro, Shimano, Avid, SRAM, Hayes, Formula and Magura (except HS11/33) can be shortened. Contains parts to shorten 10 hoses per brand. 60 pieces in total.



### ELV-AV01

Compression bolt

Avid  
10 pcs



### ELV-FM01

Compression bolt

Formula  
10 pcs



### ELV-FM04

Compression bolt  
M8 x 1

Formula  
10 pcs



### ELV-HY01

Compression bolt

Hayes  
10 pcs



### ELV-MG01

Compression bolt

Magura  
10 pcs



### ELV-MG04

Compression bolt  
M9

Magura  
10 pcs



### ELV-SH01

Compression bolt

Shimano  
10 pcs



### ELV-TK01

Compression bolt

Tektro  
10 pcs



### ELV-AV02-1

Olive

Avid  
10 pcs



### ELV-FM02

Olive

Formula  
10 pcs



### ELV-HY03

Olive

Hayes  
10 pcs



### ELV-MG02

Olive

Magura  
10 pcs



### ELV-SH02

Olive

Shimano  
10 pcs



### ELV-TK02

Olive

Tektro  
10 pcs



### ELV-AV03-1

Insert

Avid  
10 pcs



### ELV-FM03

Insert

Formula  
10 pcs



### ELV-HY02

Insert with olive

Hayes  
10 pcs



### ELV-MG03

Insert

Magura  
10 pcs



### ELV-SH03

Insert SM-BH59

Shimano  
10 pcs



### ELV-SH04

Insert SM-BH90

Shimano  
10 pcs



### ELV-TK03

Insert

Tektro  
10 pcs



### ELV-HP02

Olive

Hope  
10 pcs



### ELV-HP03

Insert

Hope  
10 pcs



### ELV-HP04

O-ring  
(small)

Hope  
10 pcs



### ELV-HP05

O-ring  
(large)

Hope  
10 pcs



## ORIGINAL BRAND HOSE FITTING SET

Shorten 2 original brand hydro hoses with fitting sets per brand. Packed in a sealbag.

### CP2019130

Shimano  
SM-BH59



### CP2019131

Shimano  
SM-BH90



### CP2019132

Magura



### CP2019133

SRAM / Avid



### CP2019134

Tektro



### CP2019135

Formula



### CP2019136

Hayes



### CP2020139

Elvedes



### CP2021069

Hope



## BRAKE

DISC BRAKE SYSTEMS

CALIPER ADAPTERS

DISC BRAKE ROTORS

DISC BRAKE PARTS

DISC BRAKE PADS

RIM BRAKE PADS

## CABLE

INNER CABLES

OUTER CABLES

ATB/RACE CABLES

CABLE KITS

CABLE PARTS

## HYDRO

ORIGINAL BRANDS

HYDRO  
COMPONENTS

SHIMANO HYDRO  
COMPONENTS

O-RINGS

## ROTATION

BEARINGS

HEADSET BEARINGS

HEADSET PARTS

PULLEY WHEELS

BOTTOM BRACKET  
GUIDE

BOTTOM BRACKETS

BOTTOM BRACKET  
PARTS

## TOOLS AND MAINTENANCE

MAINTENANCE

CABLE TOOLS

MORE TOOLS

HYDRO TOOLS

BOTTOM BRACKET  
TOOLS

## WORKSHOP

TRANSIT

BOXER

PARTNER

CADDY

PADFINDER

DISCOVERY

# HYDRO COMPONENTS

## HYDRO HOSE VOLUME BOX

20 meters hose

With Kevlar and PTFE  
Suitable for mineral and DOT oil  
Fits Elvedes parts only

2012030 Black

2012031 White



## ASSORTMENT BOX HYDRO PARTS

2012096

Assortment box which contains all hydraulic parts and accessories for Elvedes hydro hose only



### ELV2017095

Compression bolt  
M9 x 1.25

Stainless steel

10 pcs



### ELV2019115

Banjo bolt

Stainless steel

10 pcs



### ELV2012097

Insert

Brass

30 pcs



### ELV2012100

Connector M6

Stainless steel

10 pcs



### ELV2012101

Banjo

Stainless steel

10 pcs



### ELV2012104

Banjo bolt

Steel

10 pcs



### ELV2012098

Olive

Brass

40 pcs



### ELV2012099

Compression bolt  
M8 x 0.75

Stainless steel

30 pcs



### ELV2012103

Banjo bolt

Stainless steel

10 pcs



### ELV2019116

Flange bolt M9

Steel

10 pcs



### ELV2012102

Compression nut

Stainless steel

10 pcs



### ELV2012105

O-ring





Copper

30 pcs



## HYDRO HOSE

3 meters hose.  
For both front and rear brakes.  
Suitable for mineral and DOT oil.  
Fits Elvedes parts only

2011006	Black	
2011007	White	
2011008	Red	
2011009	Orange	
2011010	Blue	
2011011	Green	



## HYDRO PARTS KIT

Stainless Steel Parts.  
For both front and rear brakes.  
Fits Elvedes Hydro hose only

2011012	Kit 1 : M8 + M8
2011013	Kit 2 : M8 + Banjo
2011014	Kit 3 : Banjo + Banjo
2011015	Kit 4 : M8 + M6
2016025	Kit 5 : M8 + Banjo (Shimano)
2016009	Kit 6 : M8 X 1 + Banjo (New Form Mega/R/R1/R1R/Cura)
2016010	Kit 7 : M9 X 1.25 + Banjo (Mag. MT 4/5/5e/6/7/8)
2016011	Kit 8 : M9 X 1.25 + M6 (Mag. MT2)
2019122	Kit 9 : M9 Flange bolt + M8



## FIT YOUR KIT

### Avid/SRAM

Code, New Code, Juicy 3	Kit 1
All other Juicy, XX 2010-2011	Kit 2
Elixir, XO, XX 2012, Guide	Kit 4

### Hayes

Sole, Dyno	Kit 1
All Stroker, all Prime, Trail, Carbon, Ace	Kit 2
Nine HFX-9	Kit 4

### Magura

Gustav	Kit 2
Louise, Julie, Marta, New Marta	Kit 4
MT 4 / 5 / 5E / 6 / 7 / 8	Kit 7
MT 2, MT Sport	Kit 8

### Elvedes

HP4000	Kit 1
--------	-------

### Formula

RX, R1, The One, Mega	Kit 2
Oro	Kit 3
Mega, R, R1, R1R, Cura	Kit 6

### Tektro

All Draco, Auriga Comp (WS)	Kit 1
Orion, Volans, all other Auriga	Kit 2

### Shimano

MT200, M485, M486, M525, M535, M585, M595, M601, M665 M775, R785, M975	Kit 1
M755, M765, M776, RS785, M640, M800, M810, M988	Kit 2
M965, M966	Kit 3
M666, M675, M785, M985, M7000, M8000	Kit 5
ST-R9170, ST-R8070, ST-RX810, ST-R7070, ST-4770, ST-R400, ST-R9120, ST-R8020	Kit 9

## BRAKE

- DISC BRAKE SYSTEMS
- CALIPER ADAPTERS
- DISC BRAKE ROTORS
- DISC BRAKE PARTS
- DISC BRAKE PADS
- RIM BRAKE PADS

## CABLE

- INNER CABLES
- OUTER CABLES
- ATB/RACE CABLES
- CABLE KITS
- CABLE PARTS

## HYDRO

- ORIGINAL BRANDS
- HYDRO COMPONENTS
- SHIMANO HYDRO COMPONENTS
- O-RINGS

## ROTATION

- BEARINGS
- HEADSET BEARINGS
- HEADSET PARTS
- PULLEY WHEELS
- BOTTOM BRACKET GUIDE
- BOTTOM BRACKETS
- BOTTOM BRACKET PARTS

## TOOLS AND MAINTENANCE

- MAINTENANCE
- CABLE TOOLS
- MORE TOOLS
- HYDRO TOOLS
- BOTTOM BRACKET TOOLS

## WORKSHOP

- TRANSIT
- BOXER
- PARTNER
- CADDY
- PADFINDER
- DISCOVERY

# SHIMANO HYDRO COMPONENTS

## REPLACING

### 2020106

With Kevlar and PTFE



L = 2000mm

### 2020107

With Kevlar and PTFE



L = 2000mm

### 2021082

Brake hose for Shimano SM-BH59  
With Kevlar and PTFE  
20 m

### 2020138

Brake hose for Shimano SM-BH90  
With Kevlar and PTFE  
20 m



## REPLACING / SHORTENING

### CP2019130

Fitting set SM-BH59



### CP2019131

Fitting set SM-BH90



### ELV-SH03

Insert SM-BH59



### ELV-SH04

Insert SM-BH90



### ELV-SH02

Olive



### ELV-SH01

Compression bolt



## EXTENDING

### 2019101

SM-BH59 and SM-BH90



L = 500mm

## BLEEDING

### Mineral oil red

2016005 100 ml  
2015169 250 ml  
2020238 1 000 ml



### Mineral oil syringes

2018040  
2 pcs



### Bleed adapter set

2020095



### Bleed nipple cap

2017186  
10 pcs



## ASSORTMENT BOX O-RINGS

2019240

Replacement o-rings for calipers and master cylinders.  
Blue rings for mineral oil  
Black rings for DOT oil

Contains 20 pieces of each o-ring



### 2019241

Shimano R785, XTR  
M9000/9020, SLX M7000,  
Deore XT M8000/8020,  
Alfine S7000  
10 pcs



### 2019242

Shimano Deore, XT, XTR  
10 pcs



### 2019107

Magura MT4/5/6/7/8, Tektro  
Orion (SL), Volans, Auriga  
(SUB, Tune, Twin), Dorado,  
Gemini SL  
10 pcs



### 2019108

Magura MT4  
10 pcs



### 2019109

SRAM Elixir 5, Guide  
Ultimate, HydroR for  
flatmount  
10 pcs



### 2019110

SRAM Elixir 7/9, XO (Trail),  
XX (World Cup), HydroR for  
postmount  
10 pcs



### 2019111

SRAM Elixir 7/9, XO (Trail),  
XX (World Cup), HydroR for  
postmount and Formula R1,  
The One, Mega  
10 pcs



### 2019112

SRAM Elixir 5 and Formula  
The One  
10 pcs



### 2019113

Formula RX  
10 pcs



### 2019114

Hayes Prime, HFX-9, HFX-  
MAG  
10 pcs



## BRAKE

DISC BRAKE SYSTEMS  
CALIPER ADAPTERS  
DISC BRAKE ROTORS  
DISC BRAKE PARTS  
DISC BRAKE PADS  
RIM BRAKE PADS

## CABLE

INNER CABLES  
OUTER CABLES  
ATB/RACE CABLES  
CABLE KITS  
CABLE PARTS

## HYDRO

ORIGINAL BRANDS  
HYDRO  
COMPONENTS  
SHIMANO HYDRO  
COMPONENTS  
O-RINGS

## ROTATION

BEARINGS  
HEADSET BEARINGS  
HEADSET PARTS  
PULLEY WHEELS  
BOTTOM BRACKET  
GUIDE  
BOTTOM BRACKETS  
BOTTOM BRACKET  
PARTS

## TOOLS AND MAINTENANCE

MAINTENANCE  
CABLE TOOLS  
MORE TOOLS  
HYDRO TOOLS  
BOTTOM BRACKET  
TOOLS

## WORKSHOP

TRANSIT  
BOXER  
PARTNER  
CADDY  
PADFINDER  
DISCOVERY

ROTATION

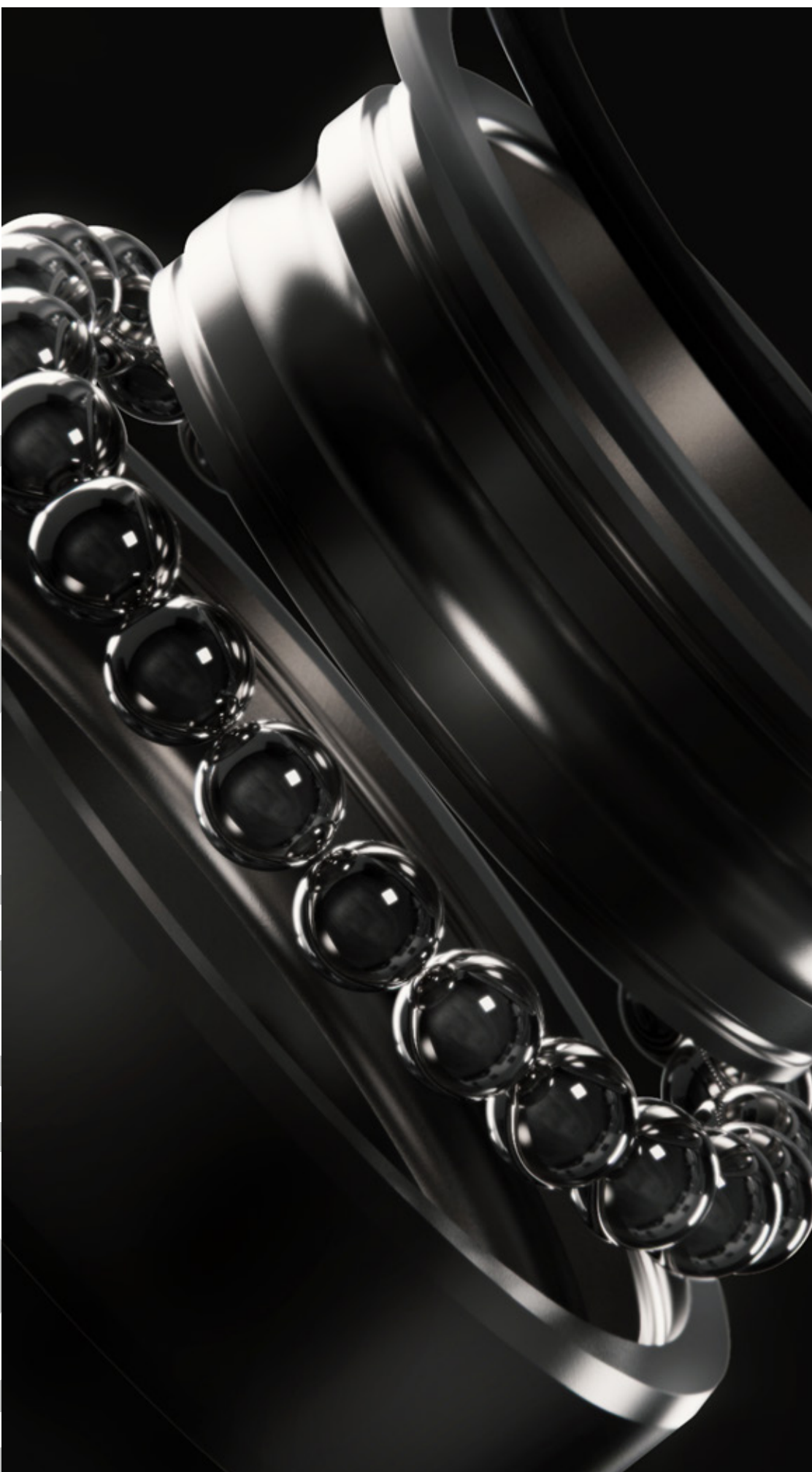



## INDUSTRIAL BEARING

- Balls separated by cage
- For full rotation parts
- ABEC 3



## INDUSTRIAL STEEL BEARINGS

2017103	608 2RS	Ø22 × Ø8 × 7
2017104	609 2RS	Ø24 × Ø9 × 7
2017105	688 2RS	Ø16 × Ø8 × 5
2017106	699 2RS	Ø20 × Ø9 × 6
2017107	6000 2RS	Ø26 × Ø10 × 8
2017108	6001 2RS	Ø28 × Ø12 × 8
2021051	6002 2RS	Ø31 × Ø16 × 10
2017109	6800 2RS	Ø19 × Ø10 × 5
2017110	6801 2RS	Ø21 × Ø12 × 5
2017111	6802 2RS	Ø24 × Ø15 × 5
2017112	6803 2RS	Ø26 × Ø17 × 5
2017113	6804 2RS	Ø32 × Ø20 × 7
2017114	6805 2RS	Ø37 × Ø25 × 7
2017115	6806 2RS	Ø42 × Ø30 × 7
2017116	6900 2RS	Ø22 × Ø10 × 6
2017117	6901 2RS	Ø24 × Ø12 × 6
2017118	6902 2RS	Ø28 × Ø15 × 7
2017119	6903 2RS	Ø30 × Ø17 × 7
2017120	6904 2RS	Ø37 × Ø20 × 9
2017121	15267 2RS	Ø26 × Ø15 × 7
2020070	15268 2RS	Ø26 × Ø15 × 8
2017195	16100 2RS	Ø28 × Ø10 × 8
2017122	17287 2RS	Ø28 × Ø17 × 7
2018039	18307 2RS	Ø30 × Ø18 × 7
2017194	24377 2RS	Ø37 × Ø24 × 7

## Steel bearing balls

2021075	1/8"	100 pcs/bag
2021076	5/32"	100 pcs/bag
2021077	3/16"	100 pcs/bag
2021078	1/4"	100 pcs/bag

## MAX BEARING

- Max amount of balls
- For minimum rotation parts
- For heavy loads
- ABEC 3



## MAX STEEL BEARINGS

2020052	606 2RS MAX	Ø17 × Ø6 × 6
2020053	608 2RS MAX	Ø22 × Ø8 × 7
2020054	688 2RS MAX	Ø16 × Ø8 × 5
2020055	698 2RS MAX	Ø19 × Ø8 × 6
2021018	3802 2RS MAX	Ø24 × Ø15 × 7
2021019	3803 2RS MAX	Ø26 × Ø17 × 7
2020066	3802W 2RS MAX	Ø24 × Ø15 × 10
2020067	3803W 2RS MAX	Ø26 × Ø17 × 10
2020056	6000 2RS MAX	Ø26 × Ø10 × 8
2020057	6001 2RS MAX	Ø28 × Ø12 × 8
2020058	6003 2RS MAX	Ø35 × Ø17 × 10
2020059	6800 2RS MAX	Ø19 × Ø10 × 5
2020060	6802 2RS MAX	Ø24 × Ø15 × 5
2021049	6803 2RS MAX	Ø26 × Ø17 × 5
2020061	6805 2RS MAX	Ø37 × Ø25 × 7
2021050	6806 2RS MAX	Ø42 × Ø30 × 7
2020062	6900 2RS MAX	Ø22 × Ø10 × 6
2020063	6901 2RS MAX	Ø24 × Ø12 × 6
2020064	6902 2RS MAX	Ø28 × Ø15 × 7
2020065	6903 2RS MAX	Ø30 × Ø17 × 7
2020069	10197 2RS MAX	Ø19 × Ø10 × 7
2020068	17286 2RS MAX	Ø28 × Ø17 × 6



## BRAKE

- DISC BRAKE SYSTEMS
- CALIPER ADAPTERS
- DISC BRAKE ROTORS
- DISC BRAKE PARTS
- DISC BRAKE PADS
- RIM BRAKE PADS

## CABLE

- INNER CABLES
- OUTER CABLES
- ATB/RACE CABLES
- CABLE KITS
- CABLE PARTS

## HYDRO

- ORIGINAL BRANDS
- HYDRO COMPONENTS
- SHIMANO HYDRO COMPONENTS
- O-RINGS

## ROTATION

- BEARINGS
- HEADSET BEARINGS
- HEADSET PARTS
- PULLEY WHEELS
- BOTTOM BRACKET GUIDE
- BOTTOM BRACKETS
- BOTTOM BRACKET PARTS

## TOOLS AND MAINTENANCE

- MAINTENANCE
- CABLE TOOLS
- MORE TOOLS
- HYDRO TOOLS
- BOTTOM BRACKET TOOLS

## WORKSHOP

- TRANSIT
- BOXER
- PARTNER
- CADDY
- PADFINDER
- DISCOVERY

# BEARINGS

## TYPE 688

Ø16 × Ø8 × 5  
Industrial: **2017105**  
MAX: **2020054**



## TYPE 606

Ø17 × Ø6 × 6  
Industrial: N/A  
MAX: **2020052**



## TYPE 698

Ø19 × Ø8 × 6  
Industrial: N/A  
MAX: **2020055**



## TYPE 6800

Ø19 × Ø10 × 5  
Industrial: **2017109**  
MAX: **2020059**



## TYPE 10197

Ø19 × Ø10 × 7  
Industrial: N/A  
MAX: **2020069**



## TYPE 699

Ø20 × Ø9 × 6  
Industrial: **2017106**  
MAX: N/A



## TYPE 6801

Ø21 × Ø12 × 5  
Industrial: **2017110**  
MAX: N/A



## TYPE 608

Ø22 × Ø8 × 7  
Industrial: **2017103**  
MAX: **2020053**



## TYPE 6900

Ø22 × Ø10 × 6  
Industrial: **2017116**  
MAX: **2020062**



## TYPE 609

Ø24 × Ø9 × 7  
Industrial: **2017104**  
MAX: N/A



## TYPE 6901

Ø24 × Ø12 × 6  
Industrial: **2017117**  
MAX: **2020063**



## TYPE 6802

Ø24 × Ø15 × 5  
Industrial: **2017111**  
MAX: **2020060**



## TYPE 3802

Ø24 × Ø15 × 7  
Industrial: N/A  
MAX: **2021018**

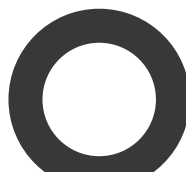

## TYPE 3802

Ø24 × Ø15 × 10  
Industrial: N/A  
MAX: **2020066**



## TYPE 6000

Ø26 × Ø10 × 8  
Industrial: **2017107**  
MAX: **2020056**



## TYPE 15267

Ø26 × Ø15 × 7  
Industrial: **2017121**  
MAX: N/A



## TYPE 15268

Ø24 × Ø15 × 8  
Industrial: **2020070**  
MAX: N/A



## TYPE 6803

Ø26 × Ø17 × 5  
Industrial: **2017112**  
MAX: **2021049**



## TYPE 3803

Ø26 × Ø17 × 7  
Industrial: N/A  
MAX: **2021019**



## TYPE 3803w

Ø26 × Ø17 × 10  
Industrial: N/A  
MAX: **2020067**



## TYPE 16100

Ø28 × Ø10 × 8  
Industrial: **2017195**  
MAX: N/A



TYPE 6001

Ø28 × Ø12 × 8  
Industrial: **2017108**  
MAX: **2020057**

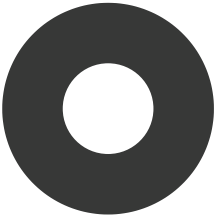

TYPE 6902

Ø28 × Ø15 × 7  
Industrial: **2017118**  
MAX: **2020064**



TYPE 17286

Ø28 × Ø17 × 6  
Industrial: N/A  
MAX: **2020068**



TYPE 17287

Ø28 × Ø17 × 7  
Industrial: **2017122**  
MAX: N/A

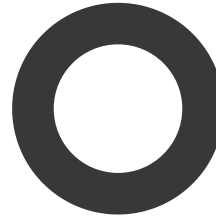

TYPE 6903

Ø30 × Ø17 × 7  
Industrial: **2017119**  
MAX: **2020065**



TYPE 18307

Ø30 × Ø18 × 7  
Industrial: **2018039**  
MAX: N/A

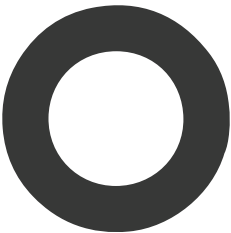

TYPE 6002

Ø31 × Ø16 × 10  
Industrial: **2021051**  
MAX: N/A



TYPE 6804

Ø32 × Ø20 × 7  
Industrial: **2017113**  
MAX: N/A



TYPE 6003

Ø35 × Ø17 × 10  
Industrial: N/A  
MAX: **2020058**



TYPE 6904

Ø37 × Ø20 × 9  
Industrial: **2017120**  
MAX: N/A

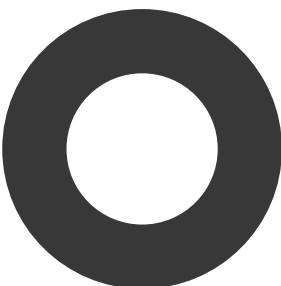

TYPE 24377

Ø37 × Ø24 × 7  
Industrial: **2017194**  
MAX: N/A

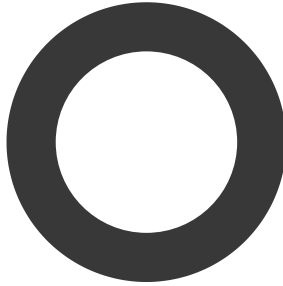

TYPE 6805

Ø37 × Ø25 × 7  
Industrial: **2017114**  
MAX: **2020061**

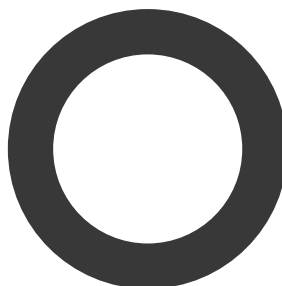

TYPE 6806

Ø42 × Ø30 × 7  
Industrial: **2017115**  
MAX: **2021050**

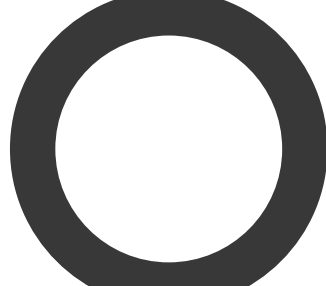

# HEADSET BEARINGS

TYPE MR168

1-1/4"  $\varnothing 46,8 \times \varnothing 34 \times 7$   $45^\circ \times 45^\circ$   
**2017138**

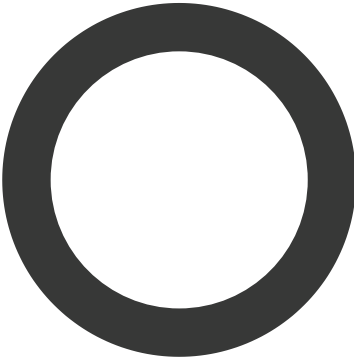

TYPE MR137

1-1/4"  $\varnothing 46,9 \times \varnothing 37 \times 7$   $45^\circ \times 45^\circ$   
**2019050**

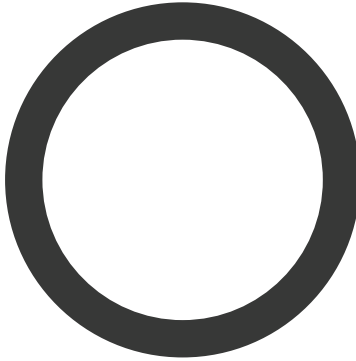

TYPE MR151

1-3/8"  $\varnothing 48,9 \times \varnothing 37 \times 7$   $45^\circ \times 45^\circ$   
**2017139**

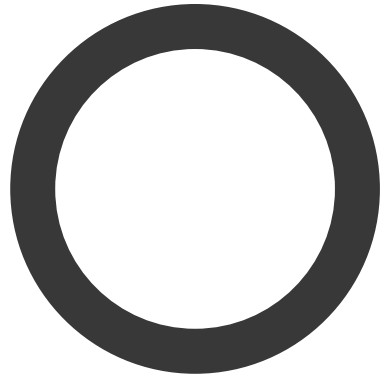

TYPE MR006

1,5"  $\varnothing 51 \times \varnothing 40 \times 6,5$   $36^\circ \times 36^\circ$   
**2017142**

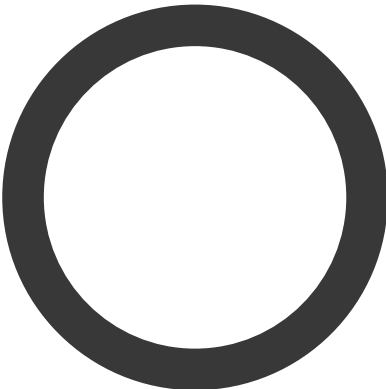

TYPE MR127

1,5"  $\varnothing 51,8 \times \varnothing 40 \times 8$   $36^\circ \times 45^\circ$   
**2017140**

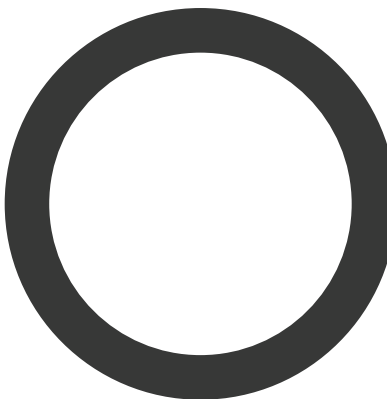

TYPE MR019

1,5"  $\varnothing 51,8 \times \varnothing 40 \times 7,5$   $36^\circ \times 45^\circ$   
**2017141**

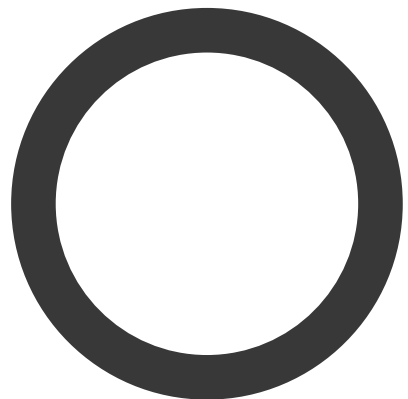

TYPE MR170

1,5"  $\varnothing 52 \times \varnothing 40 \times 7$   $45^\circ \times 45^\circ$   
**2017134**

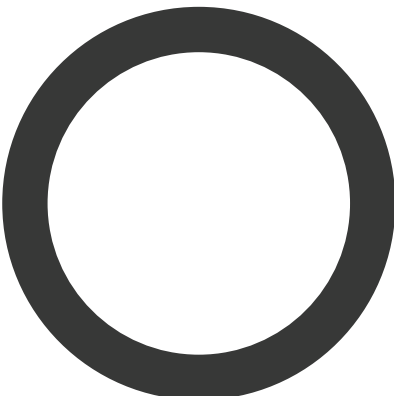

TYPE MR171

1,5"  $\varnothing 52 \times \varnothing 40 \times 7,5$   $45^\circ \times 45^\circ$   
**2017143**

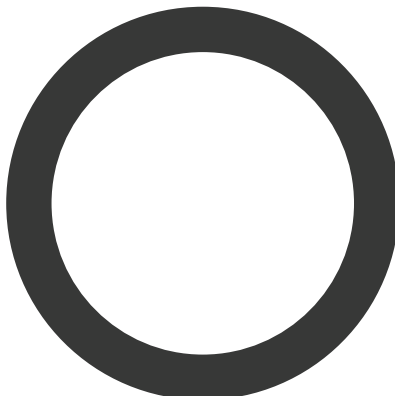

1,5"  $\varnothing 52 \times \varnothing 40 \times 6,5$   $45^\circ \times 45^\circ$   
**2020049**

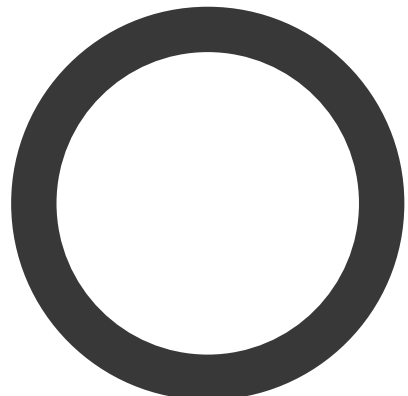

1-1/8"  $\varnothing 41 \times \varnothing 30.15 \times 7$  36° x 45°  
**2017247**

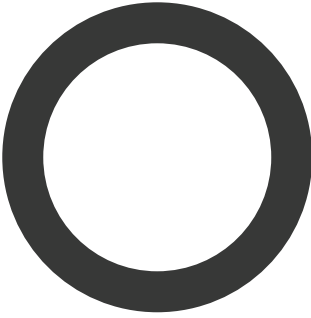

TYPE MR122  
1-1/8"  $\varnothing 41 \times \varnothing 30.2 \times 6.5$  36° x 45°  
**2017135**

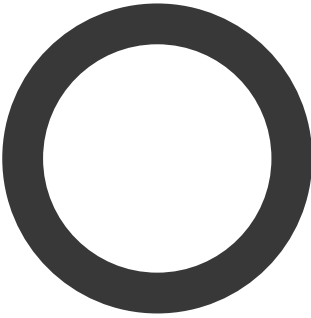

TYPE MR155  
1-1/8"  $\varnothing 41.8 \times \varnothing 30.7 \times 7.7$  45° x 45°  
**2019049**

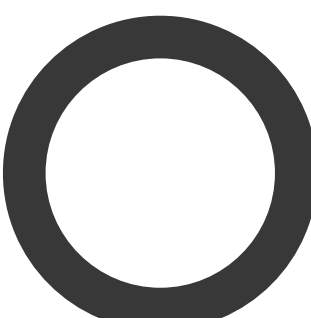

1-1/8"  $\varnothing 41.8 \times \varnothing 30.2 \times 6.5$  45° x 45°  
**2020048**

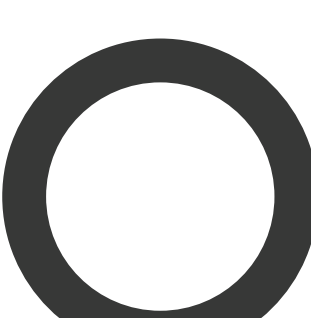

1-1/8"  $\varnothing 41 \times \varnothing 30.15 \times 7$  45° x 45°  
**2019051**

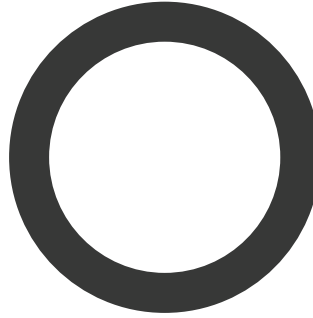

TYPE MR043  
1-1/8"  $\varnothing 41.5 \times \varnothing 30.15 \times 6.5$  36° x 36°  
**2017136**

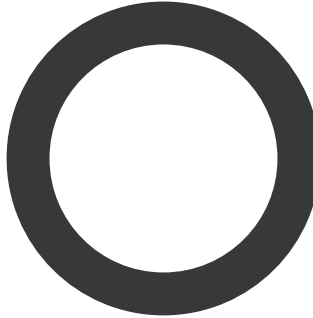

TYPE MR136  
1-1/4"  $\varnothing 41.8 \times \varnothing 32.8 \times 6$  45° x 45°  
**2019052**

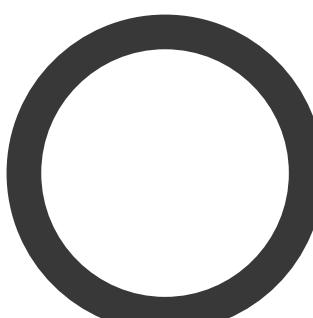

1-1/4"  $\varnothing 44 \times \varnothing 35 \times 5$   
**2020050**

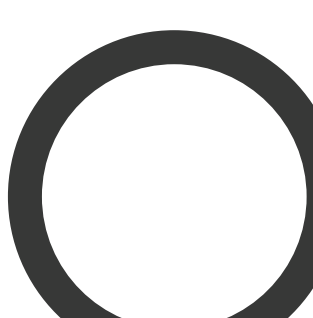

1-1/8"  $\varnothing 41 \times \varnothing 30.15 \times 7.7$  36° x 45°  
**2019053**

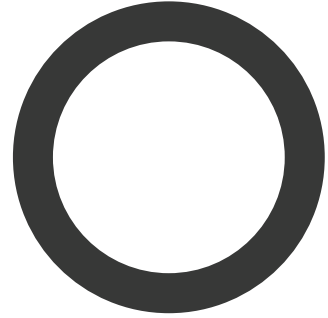

TYPE MR121  
1-1/8"  $\varnothing 41.8 \times \varnothing 30.5 \times 8$  45° x 45°  
**2017137**

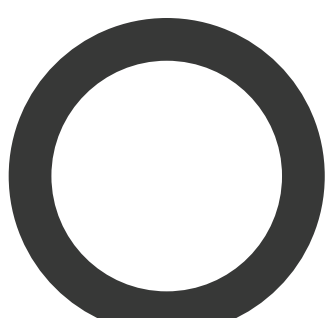

1-1/4"  $\varnothing 46 \times \varnothing 34.1 \times 7$  45° x 45°  
**2017246**

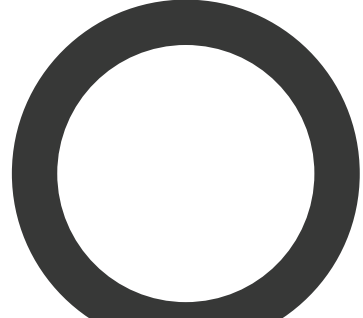

1-3/8"  $\varnothing 48 \times \varnothing 37 \times 7$   
**2020051**

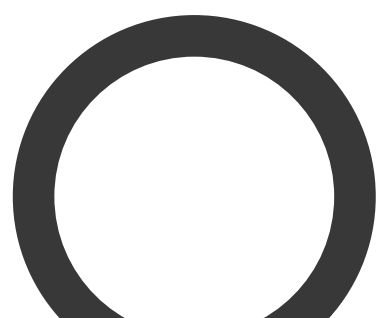

# HEADSET BEARINGS

## HEADSET BEARINGS

2019096

Assortment box high precision headset bearings

Contains 2 pcs of:

2017134	2017140	2019049
2017135	2017141	2019050
2017136	2017142	2019051
2017137	2017143	2019052
2017138	2017246	2019053
2017139	2017247	

Contains 10 pcs micro spacers  
Refill per piece



### 2017134

MR170  
1½"  
45° × 45°  
Ø52 × Ø40 × 7



### 2017135

MR122  
1⅝"  
36° × 45°  
Ø41 × Ø30,2 × 6,5



### 2017136

MR043  
1⅝"  
36° × 36°  
Ø41,5 × Ø30,15 × 6,5



### 2017137

MR121  
1⅝"  
45° × 45°  
Ø41,8 × Ø30,5 × 8



### 2017138

MR168  
1¼"  
45° × 45°  
Ø46,8 × Ø34 × 7



### 2017139

MR151  
1⅝"  
45° × 45°  
Ø48,9 × Ø37 × 7



### 2017140

MR127  
1½"  
36° × 45°  
Ø51,8 × Ø40 × 8



### 2017141

MR019  
1½"  
36° × 45°  
Ø51,8 × Ø40 × 7,5



### 2017142

MR006  
1½"  
36° × 36°  
Ø51 × Ø40 × 6,5



### 2017143

MR171  
1½"  
45° × 45°  
Ø52 × Ø40 × 7,5



### 2017246

1¼"  
45° × 45°  
Ø46 × Ø34,1 × 7



### 2017247

1⅝"  
36° × 45°  
Ø41 × Ø30,15 × 7



### 2019049

MR155  
1⅝"  
45° × 45°  
Ø41,8 × Ø30,5 × 7,7



### 2019050

MR137  
1¼"  
45° × 45°  
Ø46,9 × Ø37 × 7



### 2019051

MR136  
1⅝"  
45° × 45°  
Ø41 × Ø30,15 × 7



### 2019052

1¼"  
45° × 45°  
Ø41,8 × Ø32,8 × 6



### 2019053

1⅝"  
36° × 45°  
Ø41 × Ø30,15 × 7,7



### 2020048

1⅝"  
Ø41,8 × Ø30,2 × 6,5  
45° × 45°



### 2020049

1½"  
45° × 45°  
Ø52 × Ø40 × 6,5



### 2020050

1⅝"  
Ø44 × Ø35 × 5



### 2020051

1⅝"  
Ø48 × Ø37 × 7



## ASSORTMENT BOX HEADSET PARTS

2020140

Assortment box headset parts



**2020129**  
Fork cone for 1 1/8"  
36° (silver)  
Ø30 mm  
1 pce



**2020132**  
Fork cone for 1 1/4"  
45° (black)  
Ø33 mm  
1 pce



**2020122**  
Top cover for 1 1/8"  
Ø46 mm  
8,2 mm  
1 pce



**2020125**  
Compression ring for 1 1/8"  
36° (silver)  
5,8 mm  
1 pce



**2020128**  
Compression ring for 1 1/8"  
45° (black)  
8,4 mm  
1 pce



**2020117**  
Top cap assembly  
sphere shape  
For 1 1/8" metal tube  
Incl. bolt, star nut  
and rubber sealing cap  
5 pcs



**2020120**  
Compression device  
For 1 1/8" carbon tube  
Incl bolt and top cap  
1 pce



**2020130**  
Fork cone for 1 1/8"  
45° (black)  
Ø30 mm  
1 pce



**2020133**  
Fork cone for 1 1/2"  
36° (silver)  
Ø39,8 mm  
1 pce



**2020123**  
Top cover for 1 1/8"  
Ø50 mm  
7,2 mm  
1 pce



**2020126**  
Compression ring for 1 1/8"  
45° (black)  
5,8 mm  
1 pce



**2017144-10**  
Micro spacer for 1 1/8"  
Ø34,5 mm  
0,25 mm  
10 pcs



**2020118**  
Top cap assembly  
flat shape  
For 1 1/8" metal tube  
Incl. bolt and star nut  
1 pce



**2020121**  
Standard steel star nut  
For 1 1/8" metal tube  
5 pcs



**2020131**  
Fork cone for 1 1/8"  
36° (silver)  
Ø33 mm  
1 pce



**2020134**  
Fork cone for 1 1/2"  
45° (black)  
Ø39,8 mm  
1 pce



**2020124**  
Top cover for 1 1/8"  
Ø55 mm  
7,2 mm  
1 pce



**2020127**  
Compression ring for 1 1/8"  
36° (silver)  
8,4 mm  
1 pce



**2020136**  
Spacer for 1 1/8"  
Ø34,5 mm  
2 mm  
5 pcs



**2020119**  
Compression device  
For 1 1/8" carbon tube  
Incl. bolt, star  
nut and rubber  
sealing cap  
1 pce



**2020135**  
Rubber sealing cap  
For 5mm socket bolt  
10 pcs



### BRAKE

DISC BRAKE SYSTEMS  
CALIPER ADAPTERS  
DISC BRAKE ROTORS  
DISC BRAKE PARTS  
DISC BRAKE PADS  
RIM BRAKE PADS

### CABLE

INNER CABLES  
OUTER CABLES  
ATB/RACE CABLES  
CABLE KITS  
CABLE PARTS

### HYDRO

ORIGINAL BRANDS  
HYDRO  
COMPONENTS  
SHIMANO HYDRO  
COMPONENTS  
O-RINGS

### ROTATION

BEARINGS  
HEADSET BEARINGS  
HEADSET PARTS  
PULLEY WHEELS  
BOTTOM BRACKET  
GUIDE  
BOTTOM BRACKETS  
BOTTOM BRACKET  
PARTS

### TOOLS AND MAINTENANCE

MAINTENANCE  
CABLE TOOLS  
MORE TOOLS  
HYDRO TOOLS  
BOTTOM BRACKET  
TOOLS

### WORKSHOP

TRANSIT  
BOXER  
PARTNER  
CADDY  
PADFINDER  
DISCOVERY

# PULLEY WHEELS

## 2 × 10 TEETH

CP2017231

ABEC 3 with extra grease

1 set

Stainless sealed bearing

Including spacers compatible with:

A - Shimano 8 speed

B - Shimano 7 speed, Campagnolo 8 speed

C - Campagnolo 9 / 10 speed

D - SRAM (one hole upper pulley) 9.0SL ('98) / 9.0 ('97 - '98) / 7.0 ('97 - '98) / 5.0 ('98 - '99)"



## 2 × 11 TEETH

CP2017086

ABEC 3 with extra grease

1 set

Stainless sealed bearing

Including spacers compatible with:

A - Shimano 8 / 9 / 10 / 11 speed

B - Shimano 7 speed, Campagnolo 8 speed

C - Campagnolo 9 / 10 speed

D - SRAM 7.0 / 9.0 ('97 - '99)"

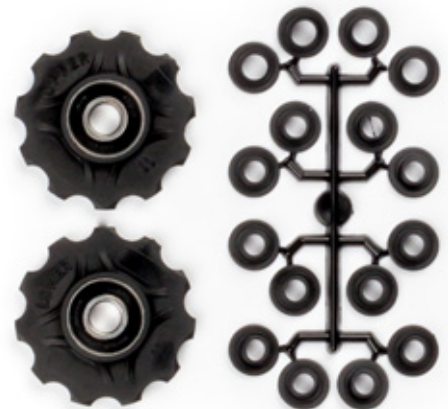

## 2 × 11 TEETH

2017086-BOX

ABEC 3 with extra grease

10 sets

Stainless sealed bearing

Including spacers compatible with:

A - Shimano 8 / 9 / 10 / 11 speed

B - Shimano 7 speed, Campagnolo 8 speed

C - Campagnolo 9 / 10 speed

D - SRAM 7.0 / 9.0 ('97 - '99)"





## 2 × 11 TEETH

CP2017100

ABEC 5 with extra grease  
1 set  
Stainless sealed bearing

Compatible with:  
Shimano 9 / 10 / 11 speed  
SRAM X0 / X9 / X7 9 speed MTB > 2011  
SRAM X0 / X9 / X7 10 speed MTB  
SRAM Apex / Rival / Force 10 speed road  
(bushing included)  
Campagnolo 11 speed



## 2 × 13 TEETH

CP2019103

ABEC 5 with extra grease  
1 set  
Stainless sealed bearing

Compatible with:  
Shimano RD-M9100 / M8100 / M7100



## BRAKE

DISC BRAKE SYSTEMS  
CALIPER ADAPTERS  
DISC BRAKE ROTORS  
DISC BRAKE PARTS  
DISC BRAKE PADS  
RIM BRAKE PADS

## CABLE

INNER CABLES  
OUTER CABLES  
ATB/RACE CABLES  
CABLE KITS  
CABLE PARTS

## HYDRO

ORIGINAL BRANDS  
HYDRO COMPONENTS  
SHIMANO HYDRO COMPONENTS  
O-RINGS

## ROTATION

BEARINGS  
HEADSET BEARINGS  
HEADSET PARTS  
PULLEY WHEELS  
BOTTOM BRACKET GUIDE  
BOTTOM BRACKETS  
BOTTOM BRACKET PARTS

## TOOLS AND MAINTENANCE

MAINTENANCE  
CABLE TOOLS  
MORE TOOLS  
HYDRO TOOLS  
BOTTOM BRACKET TOOLS

## WORKSHOP

TRANSIT  
BOXER  
PARTNER  
CADDY  
PADFINDER  
DISCOVERY

## 2 × 12 TEETH

CP2017101

ABEC 5 with extra grease  
1 set  
Narrow / wide  
Stainless sealed bearing

Compatible with:  
SRAM X01 / XX1 / X1 GX 1×11 speed  
SRAM Rival 1 / Force 1 1×11 speed



## 12 + 14 TEETH

CP2017102

ABEC 5 with extra grease  
1 set  
Narrow / wide  
Stainless sealed bearing

Compatible with:  
SRAM Eagle XX1 / X01 / NX / SX / GX 1×12 speed  
and 2×11 speed MTB



## 2 × 12 TEETH

2020097

ABEC 5 with extra grease  
1 set  
Narrow / wide  
Ceramic hybrid bearing

Compatible with:  
SRAM Force / Red eTap AXS



## 12 + 14 TEETH

2020098

ABEC 5 with extra grease  
1 set  
Narrow / wide  
Ceramic hybrid bearing

Upgrade for:  
SRAM Force / Red eTap AXS



# BOTTOM BRACKET GUIDE —

A bottom bracket shell can be threaded or non-threaded, called thread fit and press fit respectively. It is important to know which type of shell you're working with and what the shell diameter and width are, in order to select a fitting bottom bracket.

The most common thread types in thread fit shells are BSA (English thread), ITA (Italian thread) and T47 (M47×1). A thread type bottom bracket is interlocked directly with the shell. Press fit shells come in various diameters and widths, most commonly PF30 (Ø46mm), BB30 (Ø42mm) and BB86/92 (Ø41mm). Press fit bottom brackets are pressed into the shell using a press-in tool.

Another dimension you need to know in order to select a fitting bottom bracket is the spindle

diameter. Different brands and models can vary widely, from Ø30mm to tapered versions like Praxis (Ø30mm – Ø28mm). Differences between brands can also be as little as a few hundreds of millimeters.

Elvedes offers a basic range of bottom brackets, which can be easily adapted to specific types of spindles such as FSA Mega Exo and SRAM / Truvativ GXP using specific bearing caps or reducer kits.

Elvedes also offers an enhanced version of the press fit bottom bracket, called the twist fit bottom bracket. The twist fit bottom bracket can alternatively be used in a press fit shell. Replacement bearings and bearing caps are also available for maintenance.

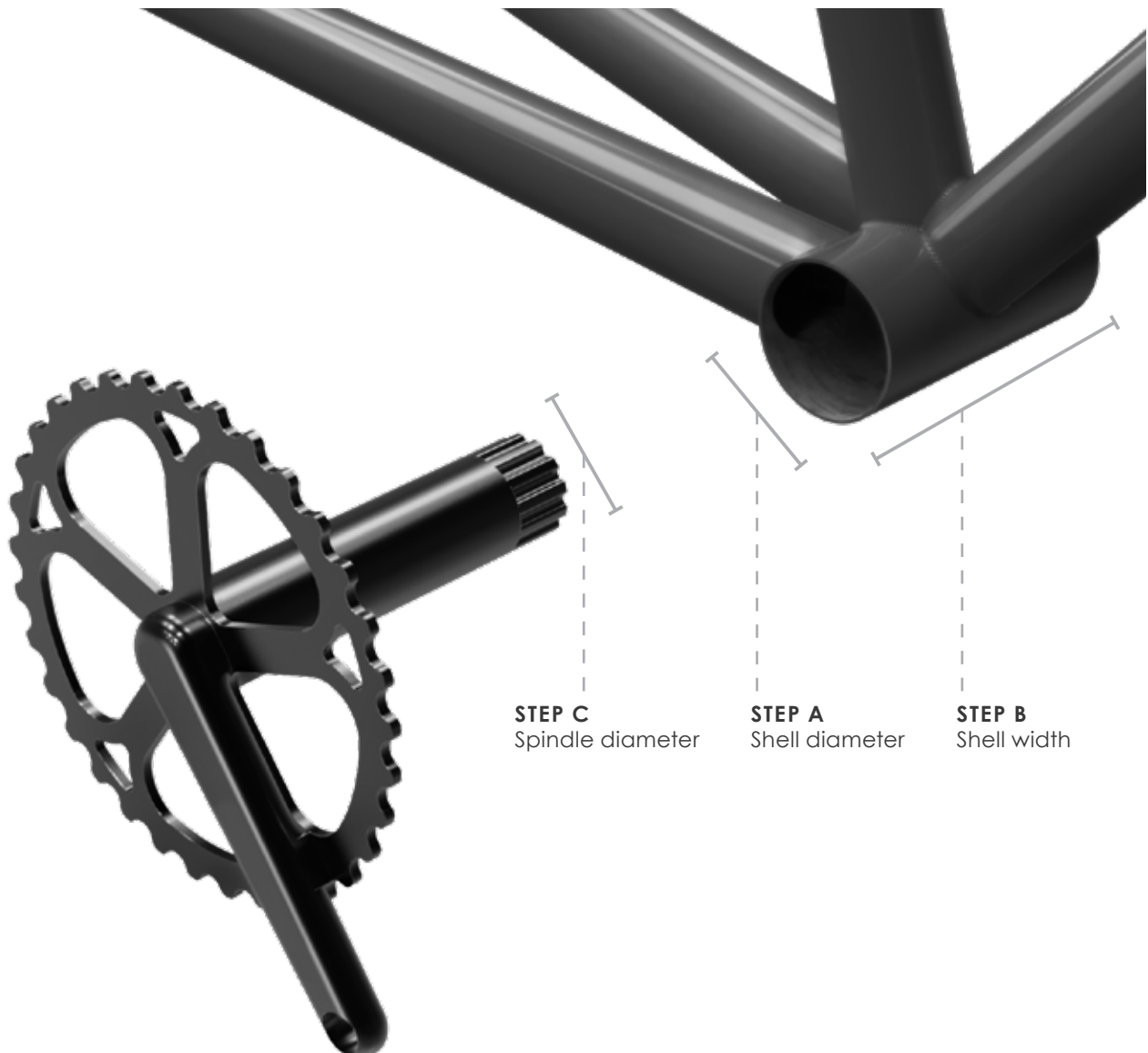

# TWIST FIT —

## ELVEDES ALWAYS STRIVES TO SUPPLY IN SOLUTIONS.

A common issue of the classic press fit bottom brackets is a squeaking and creaking sound because of a bad bearing alignment.

Press fit bottom brackets exist of three pieces which are independently pressed into the shell using a press-in tool. It often occurs that the left and right bearing are not 100% in line. This causes pressure on the bearings, wearing them out easily.

A solution to this problem is the Elvedes twist fit bottom bracket. This improved version of a press fit bottom bracket exists of two easily installed interlocking cups to create one rigid bracket in which the bearings are perfectly aligned. This makes sure the spindle can run without any sideways pressure, lifting both friction and creaking sounds.

The Elvedes CNC twist fit bottom brackets come in all sizes and can be used instead of regular press fit bottom brackets to bring your cycling experience to the next level. Once installed, the bearings can easily be replaced for maintenance while the bottom bracket stays in place. This saves a lot of time and keeps the costs low over time.

To assemble the Elvedes Twist Fit you will need the Elvedes Bottom Bracket Wrench (item no. 2018086 or the Elvedes Twist Fit Tool Kit (item no. 2018087)



### — LOW MAINTENANCE COSTS

Only the bearings can be replaced for service maintenance, while the bracket stays in place.

### — PERFECTLY IN LINE

The threaded interlocking cups allow the spindle to run freely without squeaking and creaking.

### — EASY INSTALLATION

Elvedes BB wrench required (item no. 2018086)

Scan the QR code for an online manual for (dis)assembling Elvedes twist fit bottom brackets using Twist fit tool kit.



# THREAD FIT BOTTOM BRACKETS

Shell diameter Step A	Shell width Step B	Spindle diameter Step C	Bracket item no.	Additionally required*	Replacement bearing	Replacement bearing cap
BSA	68 mm	19 mm FSA Mega Exo	2018065	2019064	2019087	2019064
		22 - 24mm SRAM/Truvativ GXP	2018065	2018080	2019087	2018083
		24mm Shimano Road	2018065		2019087	2018081
		19mm FSA Mega Exo	2018066	2018064	2019087	2019064
	68 - 73 mm	22 - 24mm SRAM/Truvativ GXP	2018067		2019087	2018081
		24mm FSA Mega Exo	2018066	2018083	2019087	2018083
		24mm Shimano MTB	2018066		2019087	2018081
		29mm SRAM DUB	2019118		2018077	
		28mm - 30mm Praxis	2020088		2018077	
		30mm IB30	2018068		2018077	
	100 mm	22 - 24mm SRAM/Truvativ GXP	2019085	2018080	2019087	2018081
		24mm Shimano Fatbike	2019085		2019087	2018081
ITA	70 mm	19 mm FSA Mega Exo	2018078	2019064	2019087	2019064
		24mm FSA Mega Exo	2018078	2018083	2019087	2018083
		24mm Shimano Road	2018078		2019087	2018081
		28mm - 30mm Praxis Road	2020089		2018077	
		29mm SRAM DUB Road	2019119		2018077	
		30mm IB30	2018079		2018077	
T47	68 mm	24mm Shimano Ext	2020093		2019087	
		28mm - 30mm Praxis Ext	2020115		2018077	
		29mm SRAM DUB Ext	2020111		2018077	
	86 mm	24mm Shimano Int Road	2020092		2019087	
		28mm - 30mm Praxis Int Road	2020114		2018077	
		29mm SRAM DUB Int Road	2020112		2018077	

Elvedes Twist fit tool kit (2018087) recommended. Elvedes Bottom bracket wrench (2018086) required.

\* To fit certain spindles, an existing bottom bracket is used which can be adapted with an additional bearing cap set or reducer kit. The additional item is mentioned in the 'additionally required' column.

# TWIST FIT BOTTOM BRACKETS

SHELL DIAMETER STEP A	SHELL WIDTH STEP B	SPINDLE DIAMETER STEP C	BRACKET ITEM NO.	ADDITIONALLY REQUIRED*	REPLACEMENT BEARING	REPLACEMENT BEARING CAP
Ø41mm	86 mm	Campagnolo Ultra Torque	2018070		2019086	
	86 - 92 mm	19mm FSA Mega Exo	2018069	2019065	2019087	2019065
		24mm FSA Mega Exo	2018069	2018084	2019087	2018084
		24mm Shimano	2018069		2019087	2018082
		22 - 24mm SRAM/Truvativ GXP	2019084	2018080	2019087	2018082
	106 -132mm	24mm Shimano Fatbike	2019084		2019087	2018082
		19mm FSA Mega Exo	2018073	2019064	2019087	2019064
	Ø42mm	68 - 73 mm	22 - 24mm SRAM/Truvativ GXP	2018073	2018080	2019087
24mm FSA Mega Exo			2018073	2018083	2019087	2018083
24mm Shimano			2018073		2019087	2018081
28 - 30mm Praxis			2020090		2018077	
29mm SRAM DUB			2019120		2018077	
Ø46mm	68 mm	Campagnolo Ultra Torque	2018074		2019086	
	68 - 73 mm	19mm FSA Mega Exo	2018073	2019064	2018087	2019064
		22 - 24mm SRAM/Truvativ GXP	2018073	2018080	2018087	2018081
		24mm FSA Mega Exo	2018073	2018083	2018087	2018083
		24mm Shimano	2018073		2018087	2018081
		28 - 30mm Praxis	2020090		2018077	
		29mm SRAM DUB	2020120		2018077	
	79 mm	24mm Shimano	2021065		2018087	2018081
	86 - 92 mm	19mm FSA Mega Exo	2020084	2019064	2019087	2019064
		22 - 24mm SRAM/Truvativ GXP	2020084	2018080	2019087	2018081
		24mm FSA Mega Exo	2020084	2018083	2019087	2018083
		24mm Shimano	2020084		2019087	2018081
		28 - 30mm Praxis	2020091		2018077	
		29mm SRAM DUB	2019121		2018077	
		30mm BB386	2018071		2018077	
		100 mm	30mm PF30 Fatbike	2020086		2018077

Elvedes Twist fit tool kit (2018087) recommended. Elvedes Bottom bracket wrench (2018086) required.

# PRESS FIT BOTTOM BRACKETS

SHELL DIAMETER STEP A	SHELL WIDTH STEP B	SPINDLE DIAMETER STEP C	BRACKET ITEM NO.	ADDITIONALLY REQUIRED*	REPLACEMENT BEARING	REPLACEMENT BEARING CAP
Ø41 mm	86 - 92 mm	19mm FSA Mega Exo	2018064	2019065	2019087	2019065
		22 - 24mm SRAM/Truvativ GXP	2018064	2018080	2019087	2018082
		24mm FSA Mega Exo	2018064	2018084	2019087	2018084
		24mm Shimano	2018064		2019087	2018082
		28 - 30mm Praxis	2020087		2018077	
		29mm SRAM DUB	2019117		2018077	
		30mm IB30	2019117		2018077	
Ø42mm	68 - 73 mm	30mm BB30	2018077		2018077	
Ø46mm	68 - 73 mm	30mm PF30	2019083		2018077	
	86 mm	24mm Shimano	2021079		2018087	2018081

\* To fit certain spindles, an existing bottom bracket is used which can be adapted with an additional bearingcap set or reducer kit. The additional item is mentioned in the 'additionally required' column.

# BOTTOM BRACKETS

## TWIST FIT

Tools required: 2018086 Bottom bracket wrench

- <sup>1</sup> Convertible to GXP with GXP reducer kit (2018080)
- <sup>2</sup> Convertible to FSA with FSA bearing caps (page 49)

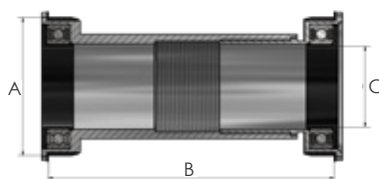

		A	B	C
2018069	BB86/92 Shimano	41 mm	86 - 92 mm	24 mm Shimano <sup>1 2</sup>
2018070	BB86/92 UT	41 mm	86 mm	Campagnolo Ultra-Torque
2018071	BB386/392	46 mm	86 - 92 mm	30 mm
	PF30	46 mm	68 - 73 mm	30 mm
2018073	BB30 Shimano	42 mm	68 - 73 mm	24 mm Shimano <sup>1 2</sup>
	PF30 Shimano	46 mm	68 - 73 mm	24 mm Shimano <sup>1 2</sup>
2018074	PF30 UT	46 mm	68 mm	Campagnolo Ultra-Torque
2019084	Shimano Fatbike	41 mm	106 - 132 mm	24 mm Shimano <sup>1</sup>
	PF30	46 mm	68 - 73 mm	30 mm
2019120	BB30	42 mm	68 - 73 mm	30 mm
	PF30 DUB	46 mm	68 - 73 mm	29 mm SRAM DUB
	BB30 DUB	42 mm	68 - 73 mm	29 mm SRAM DUB
2019121	BB386 DUB	46 mm	86 mm	29 mm SRAM DUB
2020084	BB386 Shimano	46 mm	86 mm	24 mm Shimano <sup>1 2</sup>
2020085	BB386 UT	46 mm	86 mm	Campagnolo Ultra-Torque
2020086	PF30 Fatbike	46 mm	100 mm	30 mm
	PF30	46 mm	68 - 73 mm	30 mm
2020090	BB30	42 mm	68 - 73 mm	30 mm
	PF30 Praxis	46 mm	68 - 73 mm	28 - 30 mm Praxis M30
	BB30 Praxis	42 mm	68 - 73 mm	28 - 30 mm Praxis M30
2020091	BB386 Praxis	46 mm	86 mm	28 - 30 mm Praxis M30
2021065	BB right (Cervélo only)	46 mm	79 mm	24 mm Shimano



## PRESS FIT

- <sup>1</sup> Convertible to GXP with GXP reducer kit (2018080)
- <sup>2</sup> Convertible to FSA with FSA bearing caps (page 49)

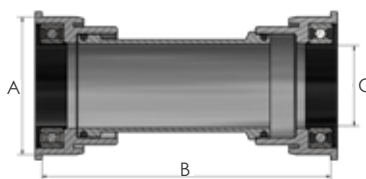

		A	B	C
2019117	BB86/92 DUB	41 mm	86 - 92 mm	29 mm SRAM DUB
	BB86/92	41 mm	86 - 92 mm	30 mm
2020087	BB86/92 Praxis	41 mm	86 - 92 mm	28 - 30 mm Praxis M30
	BB86/92	41 mm	86 - 92 mm	30 mm
2018064	BB86/92 Shimano	41 mm	86 - 92 mm	24 mm Shimano <sup>1 2</sup>
2019083	PF30	46 mm	68 - 73 mm	30 mm
2021079	BB386	46 mm	86 mm	24 mm Shimano



## THREAD FIT

Tools required: 2018086 Bottom bracket wrench

- <sup>1</sup> Convertible to GXP with GXP reducer kit (2018080)
- <sup>2</sup> Convertible to FSA with FSA bearing caps (page 49)

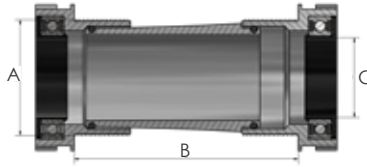

		A	B	C
2019118	BSA DUB	BSA	68 - 73 mm	29 mm SRAM DUB
2018067	BSA GXP	BSA	68 - 73 mm	22 - 24 mm SRAM / Truvativ GXP
2018068	BSA IB30	BSA	68 - 73 mm	30 mm
2020088	BSA Praxis	BSA	68 - 73 mm	28 - 30 mm Praxis M30
2019085	BSA Shim Fatbike	BSA	100 mm	24 mm Shimano <sup>1</sup>
2018066	BSA Shim MTB	BSA	68 - 73 mm	24 mm Shimano <sup>2</sup>
2018065	BSA Shim Road	BSA	68 mm	24 mm Shimano <sup>1,2</sup>
2019119	ITA DUB	ITA	70 mm	29 mm SRAM DUB
2018079	ITA IB30	ITA	70 mm	30 mm
2020089	ITA Praxis	ITA	70 mm	28 - 30 mm Praxis M30
2018078	ITA Shim Road	ITA	70 mm	24 mm Shimano <sup>2</sup>
2020111	T47 DUB External	T47	68 mm	29 mm SRAM DUB
2020112	T47 DUB Internal	T47	86 mm	29 mm SRAM DUB
2020115	T47 Praxis External	T47	68 mm	28 - 30 mm Praxis M30
2020114	T47 Praxis Internal	T47	86 mm	28 - 30 mm Praxis M30
2020093	T47 Shim External	T47	68 mm	24 mm Shimano
2020092	T47 Shim Internal	T47	86 mm	24 mm Shimano



## BRAKE

- DISC BRAKE SYSTEMS
- CALIPER ADAPTERS
- DISC BRAKE ROTORS
- DISC BRAKE PARTS
- DISC BRAKE PADS
- RIM BRAKE PADS

## CABLE

- INNER CABLES
- OUTER CABLES
- ATB/RACE CABLES
- CABLE KITS
- CABLE PARTS

## HYDRO

- ORIGINAL BRANDS
- HYDRO COMPONENTS
- SHIMANO HYDRO COMPONENTS
- O-RINGS

## ROTATION

- BEARINGS
- HEADSET BEARINGS
- HEADSET PARTS
- PULLEY WHEELS
- BOTTOM BRACKET GUIDE
- BOTTOM BRACKETS
- BOTTOM BRACKET PARTS

## TOOLS AND MAINTENANCE

- MAINTENANCE
- CABLE TOOLS
- MORE TOOLS
- HYDRO TOOLS
- BOTTOM BRACKET TOOLS

## WORKSHOP

- TRANSIT
- BOXER
- PARTNER
- CADDY
- PADFINDER
- DISCOVERY

## BEARING REPLACEMENT KIT

- <sup>1</sup> Includes bearing caps for Shimano and FSA
- <sup>2</sup> Convertible to GXP with GXP reducer kit (2018080)

- 2018077 BB30
- 2018085 BB90/95 Trek only <sup>1,2</sup>
- 2019086 Campagnolo Ultra - Torque
- 2019087 All Elvedes 24mm BB systems



## GXP REDUCER KIT

- 2018080 Reduces 24 mm to 22 mm GXP



# BOTTOM BRACKET PARTS

## ASSORTMENT BOX BOTTOM BRACKET SPACERS

2019070

Contains 157 pcs



### 2019071

Spacer ring

Plastic  
Ø30 × Ø24 × 0,5 mm  
20 pcs



### 2019072

Spacer ring

Plastic  
Ø30 × Ø24 × 1 mm  
20 pcs



### 2019073

Spacer ring

Plastic  
Ø36 × Ø30 × 0,5 mm  
20 pcs



### 2019074

Spacer ring

Plastic  
Ø36 × Ø30 × 1 mm  
20 pcs



### 2019075

Spacer ring

Aluminium  
Ø38 × Ø30 × 2 mm  
6 pcs



### 2019076

Spacer ring

Aluminium  
Ø38 × Ø30 × 5 mm  
4 pcs



### 2019077

Spacer ring

Aluminium  
Ø38 × Ø30 × 7 mm  
3 pcs



### 2019078

Spacer ring

Aluminium  
Ø38 × Ø30 × 9 mm  
2 pcs



### 2019079

Spacer ring

Aluminium  
Ø38 × Ø30 × 11 mm  
2 pcs



### 2019080

Wave washer

Aluminium  
Ø31 × Ø22 × 0,3 mm  
20 pcs



### 2019081

Wave washer

Aluminium  
Ø31 × Ø24 × 0,6 mm  
20 pcs



### 2019082

Wave washer

Aluminium  
Ø40,5 × Ø32,8 × 0,3 mm  
20 pcs





## ASSORTMENT BOX BOTTOM BRACKET BEARING CAPS

2019056

2 pcs of every bearing cap  
1 set GXP adapter



### 2018081

40 mm with edge

Shimano  
Type A  
2 pcs



### 2018082

37 mm without edge

Shimano  
Type B  
2 pcs



### 2018083

40 mm with edge

FSA  
Type C  
2 pcs



### 2018084

37 mm without edge

FSA  
Type D  
2 pcs



### 2019064

40 mm without edge

FSA 19 mm Mega Exo  
Type E  
2 pcs



### 2019065

37 mm without edge

FSA 19 mm Mega Exo  
Type F  
2 pcs



### 2019066

40 mm without edge

Shimano (fits Trek)  
Type A0  
2 pcs



### 2019067

40 mm without edge

FSA (fits Trek)  
Type C0  
2 pcs



### 2018080

GXP reducer kit  
24 mm to 22 mm



## BRAKE

DISC BRAKE SYSTEMS  
CALIPER ADAPTERS  
DISC BRAKE ROTORS  
DISC BRAKE PARTS  
DISC BRAKE PADS  
RIM BRAKE PADS

## CABLE

INNER CABLES  
OUTER CABLES  
ATB/RACE CABLES  
CABLE KITS  
CABLE PARTS

## HYDRO

ORIGINAL BRANDS  
HYDRO COMPONENTS  
SHIMANO HYDRO COMPONENTS  
O-RINGS

## ROTATION

BEARINGS  
HEADSET BEARINGS  
HEADSET PARTS  
PULLEY WHEELS  
BOTTOM BRACKET GUIDE  
BOTTOM BRACKETS  
BOTTOM BRACKET PARTS

## TOOLS AND MAINTENANCE

MAINTENANCE  
CABLE TOOLS  
MORE TOOLS  
HYDRO TOOLS  
BOTTOM BRACKET TOOLS

## WORKSHOP

TRANSIT  
BOXER  
PARTNER  
CADDY  
PADFINDER  
DISCOVERY

# TOOLS AND MAINTENANCE



## ETHANOL CLEANER

2018037  
40/60  
500 ml



## ETHANOL CLEANER REFILL

2018089  
40/60  
500 ml



## DISC CLEANER

2016020  
500 ml



## BRAKE

DISC BRAKE SYSTEMS  
CALIPER ADAPTERS  
DISC BRAKE ROTORS  
DISC BRAKE PARTS  
DISC BRAKE PADS  
RIM BRAKE PADS

## GREASE GUN

2019035  
Labels included  
Grease not included  
80 ml



## ORIGINAL NOZZLE

2020113  
Short  
Spare part



## EXTENSION NOZZLE

2019036  
Long  
100mm



## CABLE

INNER CABLES  
OUTER CABLES  
ATB/RACE CABLES  
CABLE KITS  
CABLE PARTS

## HYDRO

ORIGINAL BRANDS  
HYDRO COMPONENTS  
SHIMANO HYDRO COMPONENTS  
O-RINGS

## ASSEMBLY PASTE

2020212  
Refill for grease gun  
White  
Not for carbon parts  
110 g



## ROLLERBRAKE GREASE

2019038  
Refill for grease gun  
Black  
110 g



## LITHIUM GREASE

2019037  
Refill for grease gun  
Blue  
110 g



## ROTATION

BEARINGS  
HEADSET BEARINGS  
HEADSET PARTS  
PULLEY WHEELS  
BOTTOM BRACKET GUIDE  
BOTTOM BRACKETS  
BOTTOM BRACKET PARTS

## TOOLS AND MAINTENANCE

MAINTENANCE  
CABLE TOOLS  
MORE TOOLS  
HYDRO TOOLS  
BOTTOM BRACKET TOOLS

## MINERAL OIL BLUE

for all mineral systems

2016006 100 ml  
2015170 250 ml  
2020239 1 000 ml



## MINERAL OIL RED

for all mineral systems

2016005 100 ml  
2015169 250 ml  
2020238 1 000 ml



## DOT OIL

for all DOT systems

2015171 100 ml



## WORKSHOP

TRANSIT  
BOXER  
PARTNER  
CADDY  
PADFINDER  
DISCOVERY

# CABLE TOOLS

## CABLE PRICKER

2012029

Fits  $\varnothing 4,1$  and  $\varnothing 4,9$  mm outer cable



DEVELOPED BY 

## CABLE CUTTER BASIC

2017070



## CABLE CUTTER PROFESSIONAL

2009018  
Felco C7



## END CAP CRIMPING TOOL

2016093  
For shift and brake end caps



## FERRULE CRIMPING TOOL

2009019



## INTERNAL CABLE GUIDER

2018057  
Internal cable guider

Accessories included  
For more liners see page 27



## MECHANIC HEADLAMP

2019040

For perfect visibility during  
internal cable guideing  
and frame inspection

Beam adjustment  
function

Batteries (4× AAA)  
not included



## O-RING / SEAL REMOVAL TOOL SET

2020202

Specially designed for easily  
removing and replacing o-rings  
and bearing seals



## MULTI TOOL

2018026

Multi tool for disc brake and Centra-lock rings



## ACCESSORIES REPLACEMENT SET

2019270

Magnetic pull wire



Pull wire



Magnet connector



Di2 connector



Cable and hose connector



Inner cable connector



## PICK-UP MAGNET TOOL

2020096

For easily picking up internal  
cables, steel bearing  
balls and more

40 mm



## INNER WIRE TENSION TOOL

2019041

For shift and brake inner wires



## DISC ALIGNMENT TOOL

2019043



## BRAKE

DISC BRAKE SYSTEMS

CALIPER ADAPTERS

DISC BRAKE ROTORS

DISC BRAKE PARTS

DISC BRAKE PADS

RIM BRAKE PADS

## CABLE

INNER CABLES

OUTER CABLES

ATB/RACE CABLES

CABLE KITS

CABLE PARTS

## HYDRO

ORIGINAL BRANDS

HYDRO  
COMPONENTS

SHIMANO HYDRO  
COMPONENTS

O-RINGS

## ROTATION

BEARINGS

HEADSET BEARINGS

HEADSET PARTS

PULLEY WHEELS

BOTTOM BRACKET  
GUIDE

BOTTOM BRACKETS

BOTTOM BRACKET  
PARTS

## TOOLS AND MAINTENANCE

MAINTENANCE

CABLE TOOLS

MORE TOOLS

HYDRO TOOLS

BOTTOM BRACKET  
TOOLS

## WORKSHOP

TRANSIT

BOXER

PARTNER

CADDY

PADFINDER

DISCOVERY

## BLEEDING KIT

2012095

For mineral and DOT oil.  
Incl. adapters for Shimano, Magura, Hayes, Avid / SRAM, Formula, Tektro and Elvedes



## BLEED ADAPTER SET

2020095  
Shimano



2020224  
SRAM / Avid



2018043  
Magura



2018047  
Hayes



2018044  
Tektro



2018048  
Elvedes HP4000



2018045  
Formula



## OIL SYRINGES

2018040 Mineral oil syringes 2 pcs  
2018041 DOT oil syringes 2 pcs



## SNAP-ON CROWS FOOT 8 MM

2020094

For compression bolts (8 mm)  
Fits 1/4" torque wrench



## END PRESS

2017159

For fast and easily pressing inserts and banjos into hydraulic hose

Not suitable for Magura HS11/33

2018112  
Spare insert driver



## OPEN RING WRENCH 7 / 8

2017056

Specially designed for Shimano bleed bolt (7 mm)  
For easy access to compression bolts (8 mm)



## HOSE CUTTER BASIC

2019042

For smooth and burr-free cutted hydraulic hose  
Prevents leakage and damage of the hose

For consumer use

Spare blade included inside



## HOSE CUTTER PROFESSIONAL

2019124

For smooth and burr-free cutted hydraulic hose  
Prevents leakage and damage of the hose

For professional use

2019232  
Spare blade



## TWIST FIT TOOL KIT

2018087

Tool kit to (dis)assemble all Elvedes twist fit, thread fit and SRAM DUB bottom brackets.

Dimensions casing:  
36 × 27 × 7,5 cm



## BEARING SERVICE KIT

2018088

Tool kit to (dis)assemble bottom bracket bearings

Dimensions casing:  
22,5 × 11,5 × 4 cm



## BOTTOM BRACKET WRENCH

2018086

Bottom bracket wrench for all Elvedes twist fit and thread fit systems

16 notch / 44 mm  
12 notch / 48,5 mm



## SRAM DUB TOOL ADAPTER

2019069

For Elvedes Twist fit and thread fit and original SRAM DUB



## BRAKE

- DISC BRAKE SYSTEMS
- CALIPER ADAPTERS
- DISC BRAKE ROTORS
- DISC BRAKE PARTS
- DISC BRAKE PADS
- RIM BRAKE PADS

## CABLE

- INNER CABLES
- OUTER CABLES
- ATB/RACE CABLES
- CABLE KITS
- CABLE PARTS

## HYDRO

- ORIGINAL BRANDS
- HYDRO COMPONENTS
- SHIMANO HYDRO COMPONENTS
- O-RINGS

## ROTATION

- BEARINGS
- HEADSET BEARINGS
- HEADSET PARTS
- PULLEY WHEELS
- BOTTOM BRACKET GUIDE
- BOTTOM BRACKETS
- BOTTOM BRACKET PARTS

## TOOLS AND MAINTENANCE

- MAINTENANCE
- CABLE TOOLS
- MORE TOOLS
- HYDRO TOOLS
- BOTTOM BRACKET TOOLS

## WORKSHOP

- TRANSIT
- BOXER
- PARTNER
- CADDY
- PADFINDER
- DISCOVERY





## TRANSIT

2016042

No displays included

Dimensions  
97x180x41 cm

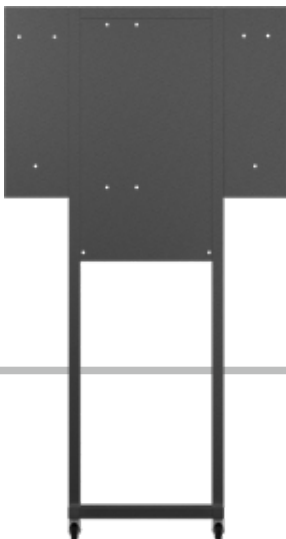

In order to increase efficiency in the workshop, Elvedes has developed a compact all-in-one mobile frame. This facilitates you to quickly and easily find all components you need for replacing cables and brake parts. No displays included. See page 74 - 79

5 full displays = Transit for free

### BRAKE

- DISC BRAKE SYSTEMS
- CALIPER ADAPTERS
- DISC BRAKE ROTORS
- DISC BRAKE PARTS
- DISC BRAKE PADS
- RIM BRAKE PADS

### CABLE

- INNER CABLES
- OUTER CABLES
- ATB/RACE CABLES
- CABLE KITS
- CABLE PARTS

### HYDRO

- ORIGINAL BRANDS
- HYDRO COMPONENTS
- SHIMANO HYDRO COMPONENTS
- O-RINGS

### ROTATION

- BEARINGS
- HEADSET BEARINGS
- HEADSET PARTS
- PULLEY WHEELS
- BOTTOM BRACKET GUIDE
- BOTTOM BRACKETS
- BOTTOM BRACKET PARTS

### TOOLS AND MAINTENANCE

- MAINTENANCE
- CABLE TOOLS
- MORE TOOLS
- HYDRO TOOLS
- BOTTOM BRACKET TOOLS

### WORKSHOP

- TRANSIT
- BOXER
- PARTNER
- CADDY
- PADFINDER
- DISCOVERY

# BOXER

## BOXER

2017027

Dimensions

53 x 36 x 36 cm

Fasteners included



### Free choice of cable types!

3 volume boxes stainless inner cable  
4 volume boxes outer cable  
See page 25 + 27

Full display = display for free



## PARTNER

2018115

Dimensions  
53 x 14 x 7cm

Smart fix system



## BRAKE

- DISC BRAKE SYSTEMS
- CALIPER ADAPTERS
- DISC BRAKE ROTORS
- DISC BRAKE PARTS
- DISC BRAKE PADS
- RIM BRAKE PADS

## CABLE

- INNER CABLES
- OUTER CABLES
- ATB/RACE CABLES
- CABLE KITS
- CABLE PARTS

## HYDRO

- ORIGINAL BRANDS
- HYDRO COMPONENTS
- SHIMANO HYDRO COMPONENTS
- O-RINGS

## ROTATION

- BEARINGS
- HEADSET BEARINGS
- HEADSET PARTS
- PULLEY WHEELS
- BOTTOM BRACKET GUIDE
- BOTTOM BRACKETS
- BOTTOM BRACKET PARTS

## TOOLS AND MAINTENANCE

- MAINTENANCE
- CABLE TOOLS
- MORE TOOLS
- HYDRO TOOLS
- BOTTOM BRACKET TOOLS

## WORKSHOP

- TRANSIT
- BOXER
- PARTNER
- CADDY
- PADFINDER
- DISCOVERY

### Free choice of cable parts!

10 jars  
See page 34 - 38

Full display = display for free

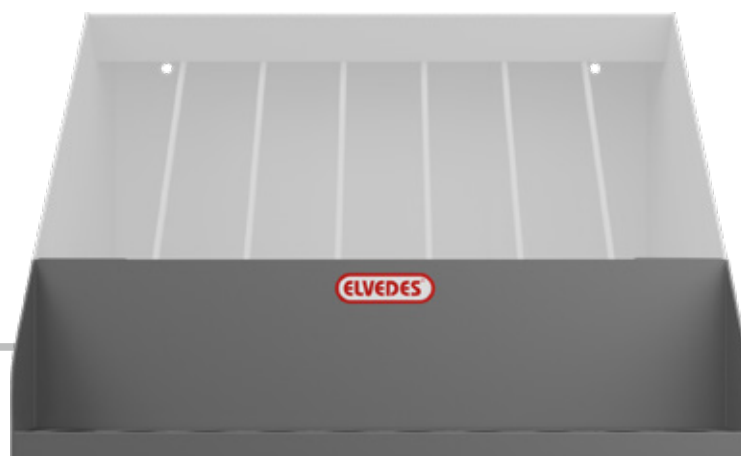

## CADDY

2017091

Dimensions  
19,5 x 65 x 12,5 cm

Fasteners included



### Free choice of rim brake pads!

Choose 3 boxes with  
25 pairs rim brake pads

See page 21-23

Full display = display for free

## PADFINDER

2017024

Dimensions  
13 x 65 x 12,5 cm

Fasteners included



## BRAKE

DISC BRAKE SYSTEMS  
CALIPER ADAPTERS  
DISC BRAKE ROTORS  
DISC BRAKE PARTS  
DISC BRAKE PADS  
RIM BRAKE PADS

## CABLE

INNER CABLES  
OUTER CABLES  
ATB/RACE CABLES  
CABLE KITS  
CABLE PARTS

## HYDRO

ORIGINAL BRANDS  
HYDRO COMPONENTS  
SHIMANO HYDRO COMPONENTS  
O-RINGS

## ROTATION

BEARINGS  
HEADSET BEARINGS  
HEADSET PARTS  
PULLEY WHEELS  
BOTTOM BRACKET GUIDE  
BOTTOM BRACKETS  
BOTTOM BRACKET PARTS

## TOOLS AND MAINTENANCE

MAINTENANCE  
CABLE TOOLS  
MORE TOOLS  
HYDRO TOOLS  
BOTTOM BRACKET TOOLS

## WORKSHOP

TRANSIT  
BOXER  
PARTNER  
CADDY  
PADFINDER  
DISCOVERY

### Free choice of disc brake pads!

Choose 4 boxes with  
10 pairs disc brake pads

See page 15-19

Full display = display for free



## DISCOVERY STARTER KIT

2020045

pair of each disc brake pad in organic compound

The Discovery can be used in 3 different settings:

1. Swing display (use additional arm)
2. Wall display
3. Counter display (use additional bottom base)

Necessary parts and fasteners included

Dimensions

38 x 65,5 x 15 cm



### Free choice of disc brake pads!

Choose 100 pairs disc brake pads to fill the Discovery

See page 15-19

Full display = display for free



## DISCOVERY

2016074

The Discovery can be used in 3 different settings:

1. Swing display (use additional arm)
2. Wall display
3. Counter display (use additional bottom base)

Necessary parts and fasteners included

Dimensions  
38 x 65,5 x 15 cm

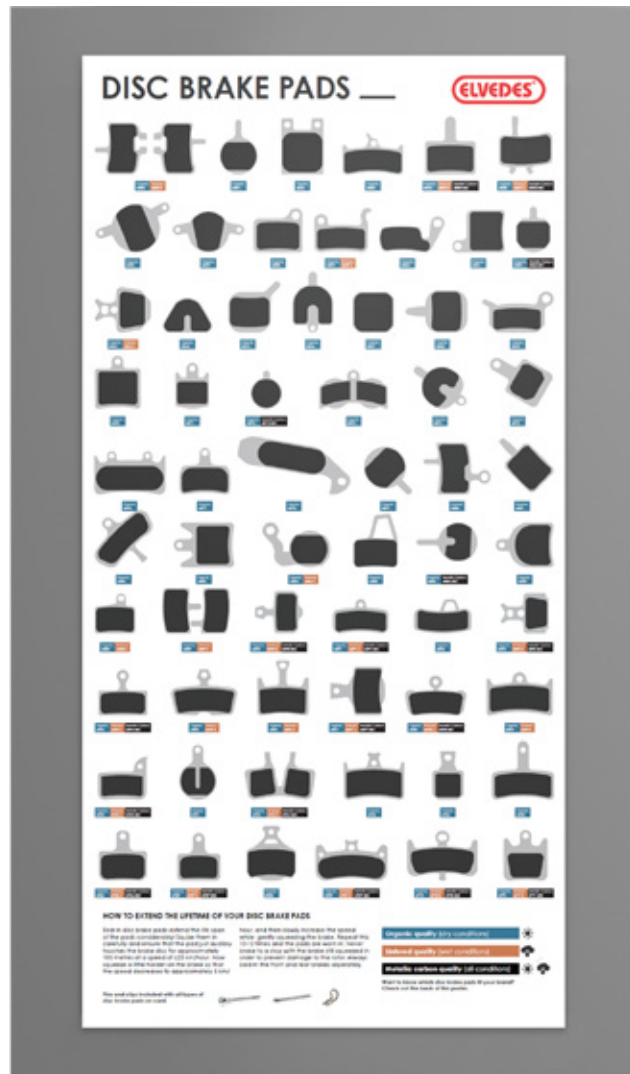

## BRAKE

- DISC BRAKE SYSTEMS
- CALIPER ADAPTERS
- DISC BRAKE ROTORS
- DISC BRAKE PARTS
- DISC BRAKE PADS
- RIM BRAKE PADS

## CABLE

- INNER CABLES
- OUTER CABLES
- ATB/RACE CABLES
- CABLE KITS
- CABLE PARTS

## HYDRO

- ORIGINAL BRANDS
- HYDRO COMPONENTS
- SHIMANO HYDRO COMPONENTS
- O-RINGS

## ROTATION

- BEARINGS
- HEADSET BEARINGS
- HEADSET PARTS
- PULLEY WHEELS
- BOTTOM BRACKET GUIDE
- BOTTOM BRACKETS
- BOTTOM BRACKET PARTS

## TOOLS AND MAINTENANCE

- MAINTENANCE
- CABLE TOOLS
- MORE TOOLS
- HYDRO TOOLS
- BOTTOM BRACKET TOOLS

## WORKSHOP

- TRANSIT
- BOXER
- PARTNER
- CADDY
- PADFINDER
- DISCOVERY

### Free choice of disc brake pads!

Choose 100 pairs disc brake pads to fill the Discovery

See page 15-19

Full display = display for free





**Bike components.**



**Elvedes  
Youtube  
Channel**  
scan QR

**Elvedes.com**

info@elvedes.com  
+31 (0)416 374 597

**Visiting address**

Grutter 7  
NL-5253 RM Nieuwkuijk  
The Netherlands

**Item no. 2021091**



8 716706 025705